

Automation systems
Drive solutions



Controls
Inverters

Motors

Gearboxes
Engineering Tools

Contents of the L-force catalogue

About Lenze		Lenze makes many things easy for you. A matter of principle: the right products for every application. L-force product portfolio		
Automation systems		Controller-based Automation	1.1	
		Drive-based automation	1.2	
Drive solutions		HighLine tasks	2.1	
		StateLine tasks	2.2	
		Baseline tasks	2.3	
Controls	Cabinet Controller	Controller 3200 C	3.1	
		I/O system 1000	3.2	
	Panel Controller	Controller p500	3.3	
		Monitor Panel	3.4	
Inverters	Decentralised	Inverter Drives 8400 protec	4.1	
		Inverter Drives 8400 motec	4.2	
		Inverter Drives SMV IP65	4.3	
	Cabinet	Servo Drives 9400 HighLine	4.4	
		Inverter Drives 8400 TopLine	4.5	
		Servo Inverters i700	4.6	
		Inverter Drives 8400 HighLine	4.7	
		Inverter Drives 8400 StateLine	4.8	
		Inverter Drives SMV IP31	4.9	
		Inverter Drives 8400 Baseline	4.10	
Motors	Servo motors	MCS synchronous servo motors	5.1	
		MD□KS synchronous servo motors	5.2	
		MQA asynchronous servo motors	5.3	
		MCA asynchronous servo motors	5.4	
	Three-phase AC motors	MF three-phase AC motors	5.5	
		MH three-phase AC motors	5.6	
		MD three-phase AC motors	5.7	
		m300 Lenze Smart Motor	5.8	
		MD/MH basic three-phase AC motors	5.9	
Gearboxes	Axial gearbox	g700-P planetary gearbox	6.1	
		MPR/MPG planetary gearboxes	6.2	
		g500-H helical gearbox	6.3	
		GST helical gearboxes	6.4	
		g500-S shaft-mounted helical gearbox	6.5	
		GFL shaft-mounted helical gearboxes	6.6	
	Right-angle gearbox	g500-B bevel gearbox	6.7	
		GKR bevel gearboxes	6.8	
		GKS helical-bevel gearboxes	6.9	
		GSS helical-worm gearboxes	6.10	
	Motor data	Assignment see above	6.11	
	Engineering Tools		Navigator	7.1
			Drive Solution Designer	7.2
		Drive Solution Catalogue	7.3	
		Engineer	7.4	
		PLC Designer	7.5	
		VisiWinNET®	7.6	
		EASY Starter	7.7	

 Selected portfolio
 Additional portfolio

Lenze makes many things easy for you.

With our motivated and committed approach, we work together with you to create the best possible solution and set your ideas in motion - whether you are looking to optimise an existing machine or develop a new one. We always strive to make things easy and seek perfection therein. This is anchored in our thinking, in our services and in every detail of our products. It's as easy as that!

1

Developing ideas

Are you looking to build the best machine possible and already have some initial ideas? Then get these down on paper together with us, starting with small innovative details and stretching all the way to completely new machines. Working together, we will develop an intelligent and sustainable concept that is perfectly aligned with your specific requirements.

4

Manufacturing machines

Functional diversity in perfect harmony: as one of the few full-range providers in the market, we can provide you with precisely those products that you actually need for any machine task – no more and no less. Our L-force product portfolio, a consistent platform for implementing drive and automation tasks, is invaluable in this regard.

2

Drafting concepts

We see welcome challenges in your machine tasks, supporting you with our comprehensive expertise and providing valuable impetus for your innovations. We take a holistic view of the individual motion and control functions here and draw up consistent, end-to-end drive and automation solutions for you - keeping everything as easy as possible and as extensive as necessary.

5

Ensuring productivity

Productivity, reliability and new performance peaks on a daily basis – these are our key success factors for your machine. After delivery, we offer you cleverly devised service concepts to ensure continued safe operation. The primary focus here is on technical support, based on the excellent application expertise of our highly-skilled and knowledgeable after-sales team.

3

Implementing solutions

Our easy formula for satisfied customers is to establish an active partnership with fast decision-making processes and an individually tailored offer. We have been using this simple principle to meet the ever more specialised customer requirements in the field of mechanical engineering for many years.

A matter of principle: the right products for every application.

Lenze's extensive L-force product portfolio follows a very simple principle. The functions of our finely scaled products are assigned to the three lines Base-Line, State-Line or High-Line.

But what does this mean for you? It allows you to quickly recognise which products represent the best solution for your own specific requirements.

Powerful products with a major impact:

- Easy handling
- High quality and durability
- Reliable technologies in tune with the latest developments

Lenze products undergo the most stringent testing in our own laboratory. This allows us to ensure that you will receive consistently high quality and a long service life. In addition to this, five logistics centres ensure that the Lenze products you select are available for quick delivery anywhere across the globe. It's as easy as that!

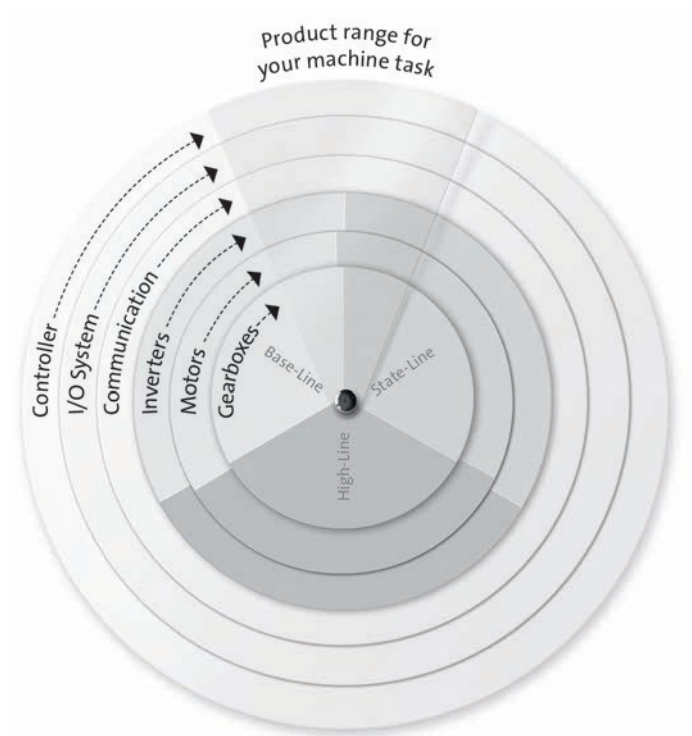

L-force product portfolio

Controls

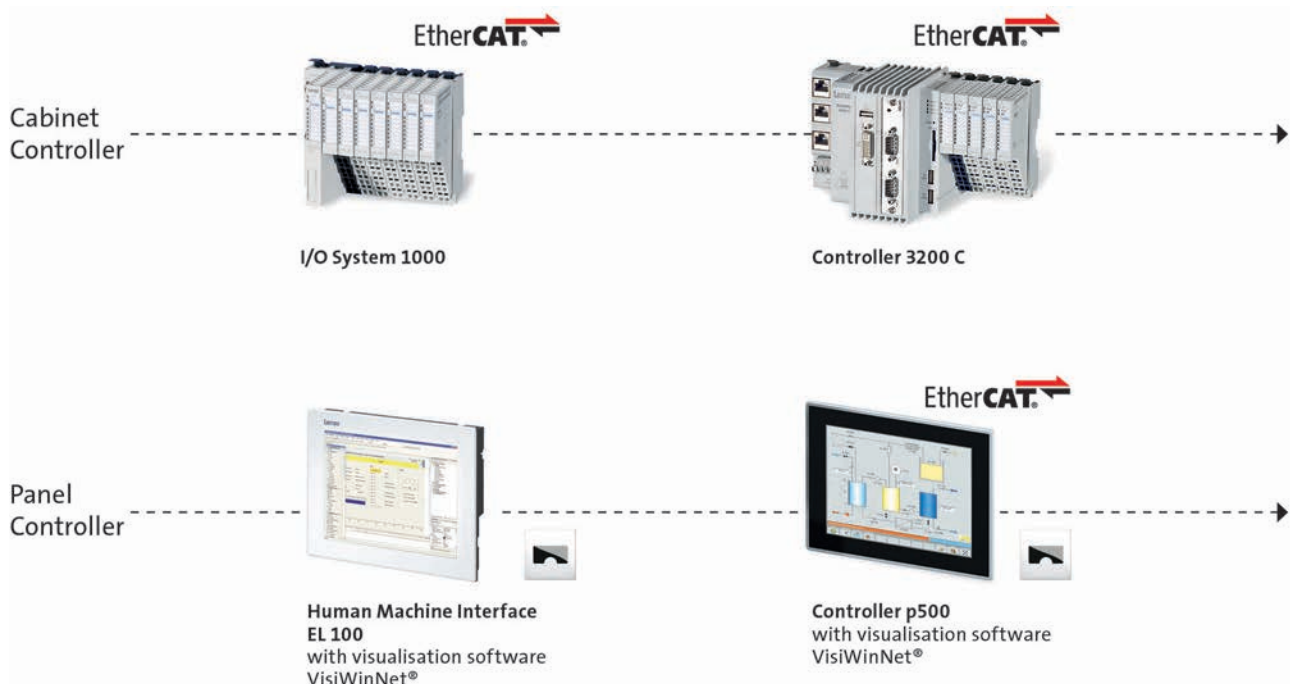

Engineering Tools

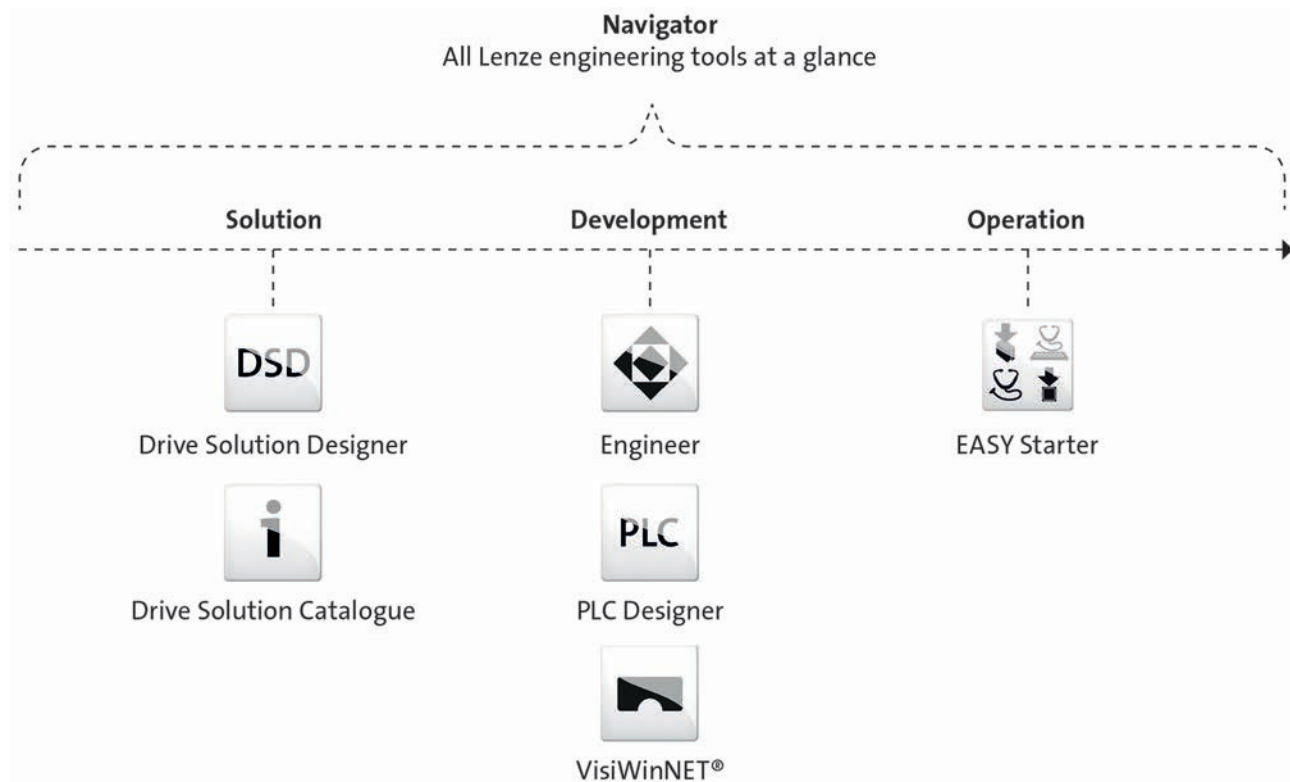

L-force product portfolio

Inverters

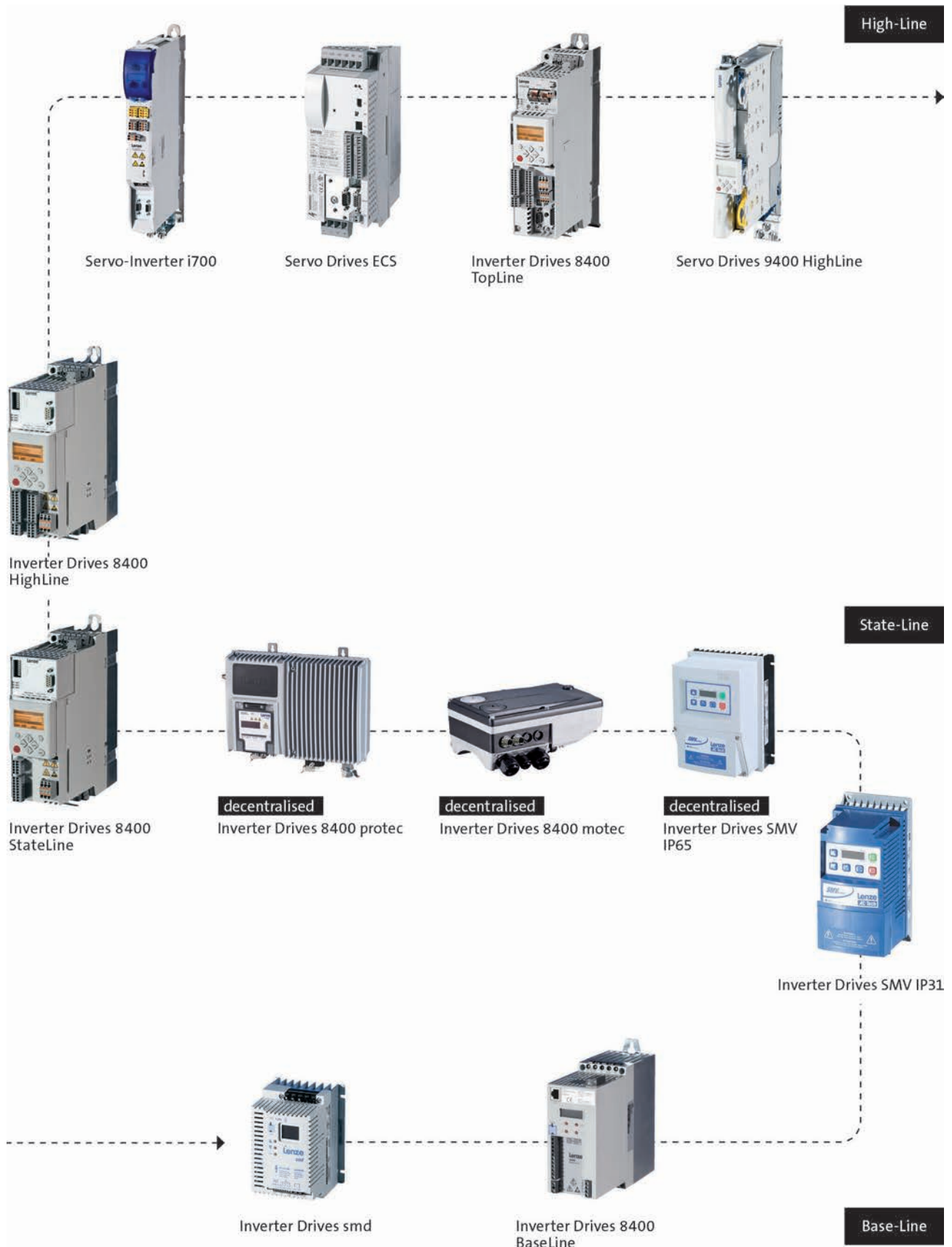

L-force product portfolio

Motors



L-force product portfolio

Gearboxes

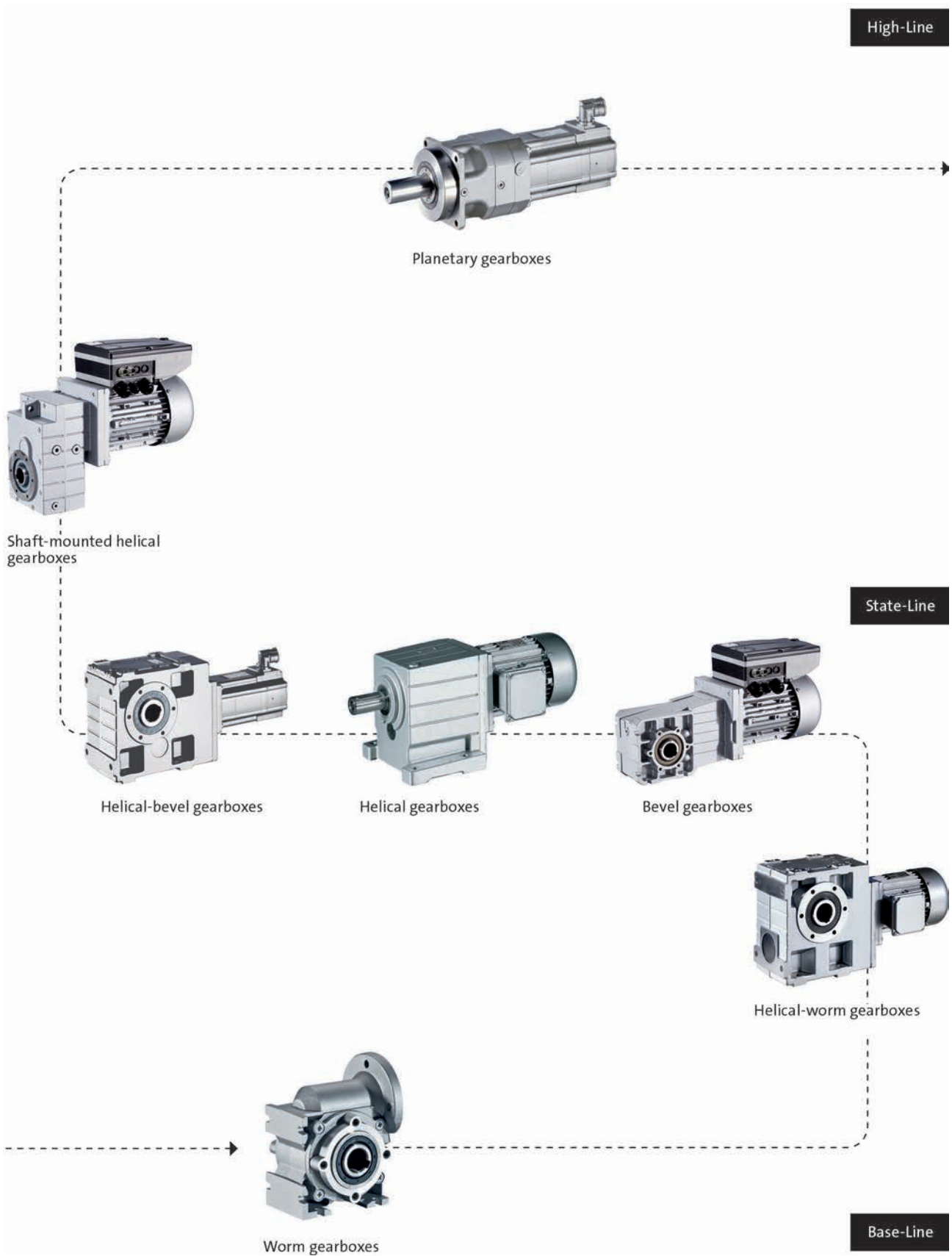

Motors

MQA asynchronous servo motors

66 to 1,100 Nm

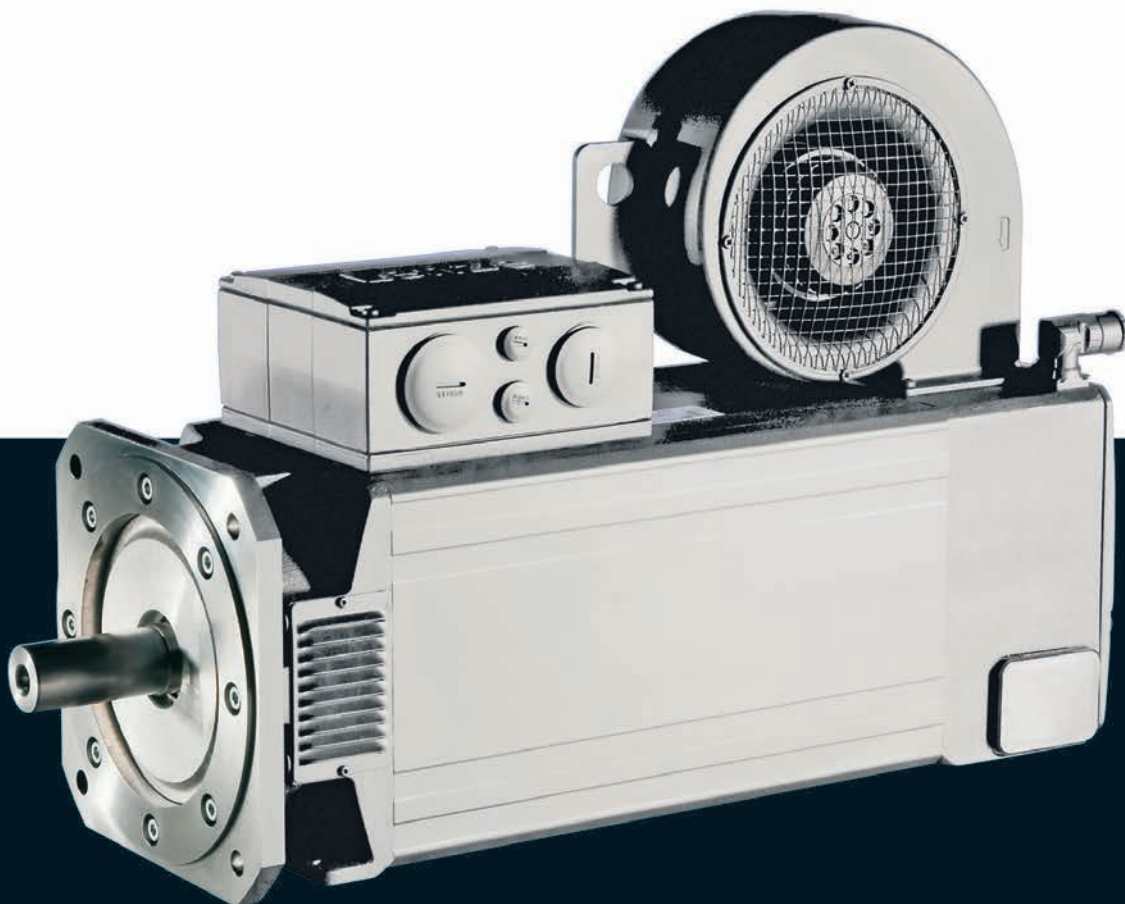

MQA asynchronous servo motors

Contents



General information	List of abbreviations	5.3 - 4
	Product key	5.3 - 6
	Product information	5.3 - 8
	Functions and features	5.3 - 9
	Dimensioning	5.3 - 10
Technical data	Standards and operating conditions	5.3 - 17
	Permissible radial and axial forces	5.3 - 18
	Rated data, forced ventilated	5.3 - 20
	Selection tables, Servo Drives 9400 HighLine	5.3 - 21
	Selection tables, Inverter Drives 8400 TopLine	5.3 - 23
	Selection tables, Servo Inverter 9300	5.3 - 25
	Torque characteristics	5.3 - 27
	Dimensions, forced ventilated	5.3 - 32
Accessories	Spring-applied holding brake	5.3 - 37
	Resolver	5.3 - 39
	Incremental encoder and SinCos absolute value encoder	5.3 - 40
	Blowers	5.3 - 42
	Temperature monitoring	5.3 - 43
	ICN connector	5.3 - 44



List of abbreviations

$\eta_{100\%}$	[%]	Efficiency
$\cos \phi$		Power factor
du/dt	[kV/ μ s]	Insulation resistance
$F_{ax,-}$	[N]	Min. axial force
$F_{ax,+}$	[N]	Max. axial force
$f_{in,max}$	[Hz]	Max. input frequency
f_{max}	[kHz]	Limit frequency
f_{max}	[kHz]	Max. switching frequency
f_N	[Hz]	Rated frequency
F_{rad}	[N]	Max. radial force
H_{max}	[m]	Site altitude
I_0	[A]	Standstill current
I_{max}	[A]	Max. short-time DC-bus current
I_{max}	[A]	Max. current
I_{max}	[A]	Max. current consumption
I_{max}	[A]	Max. current
I_{max}	[A]	Max. DC-bus current
I_N	[A]	Rated current
J	[kgcm ²]	Moment of inertia
J_{MB}	[kgcm ²]	Moment of inertia
$KE_{LL\ 150\ ^\circ C}$	[V /1000 rp]	Voltage constant
$Kt_{0\ 150\ ^\circ C}$	[Nm/A]	Torque constant
L	[mH]	Mutual inductance
$L_{1\sigma}$	[mH]	Stator leakage inductance
$L_{2\sigma}$	[mH]	Rotor leakage inductance
L_N	[mH]	Rated inductance
m	[kg]	Mass
M_0	[Nm]	Stall torque
$M_{0,max}$	[Nm]	Max. standstill torque
M_{av}	[Nm]	Average dynamic torque
M_{max}	[Nm]	Max. torque
M_N	[Nm]	Rated torque
n_{eto}	[r/min]	Transition speed
n_k	[r/min]	Speed
n_{max}	[r/min]	Max. speed

n_N	[r/min]	Rated speed
P_N	[kW]	Rated power
Q_E	[J]	Maximum switching energy
R	[Ω]	Insulation resistance
R	[Ω]	Min. insulation resistance
R_1	[Ω]	Stator impedance
R_2	[Ω]	Charging resistor
R_2	[Ω]	Rotor impedance
$R_{UV\ 150\ ^\circ C}$	[Ω]	Stator impedance
$R_{UV\ 20\ ^\circ C}$	[Ω]	Stator impedance
$S_{h\u00fc}$	[1/h]	Transition operating frequency
T	[$^\circ C$]	Operating temperature
T	[$^\circ C$]	Rated temperature
T	[$^\circ C$]	Max. ambient temperature of bearing
T	[$^\circ C$]	Max. surface temperature
T	[$^\circ C$]	Max. ambient temperature for transport
T	[$^\circ C$]	Min. ambient storage temperature
T	[$^\circ C$]	Min. ambient temperature for transport
T	[$^\circ C$]	Ambient temperature
t_1	[ms]	Engagement time
t_2	[ms]	Disengagement time
$T_{opr,max}$	[$^\circ C$]	Max. ambient operating temperature
$T_{opr,min}$	[$^\circ C$]	Min. ambient operating temperature
$U_{in,max}$	[V]	Max. input voltage
$U_{in,min}$	[V]	Min. input voltage
U_{max}	[V]	Max. mains voltage
U_{max}	[V]	Min. input voltage
U_{min}	[V]	Min. mains voltage
$U_{N, AC}$	[V]	Rated voltage
$U_{N, DC}$	[V]	Rated voltage
Z_{ro}	[Ω]	Rotor impedance
Z_{rs}	[Ω]	Impedance
Z_{so}	[Ω]	Stator impedance

MQA asynchronous servo motors

General information



List of abbreviations

CE	Communauté Européenne
CSA	Canadian Standards Association
DIN	Deutsches Institut für Normung e.V.
EMC	Electromagnetic compatibility
EN	European standard
GOST	Certificate for Russian Federation
IEC	International Electrotechnical Commission
IM	International Mounting Code
IP	International Protection Code
NEMA	National Electrical Manufacturers Association
UkrSEPRO	Certificate for Ukraine
UL	Underwriters Laboratory Listed Product
UR	Underwriters Laboratory Recognized Product
VDE	Verband deutscher Elektrotechniker (Association of German Electrical Engineers)

MQA asynchronous servo motors

General information



Product key

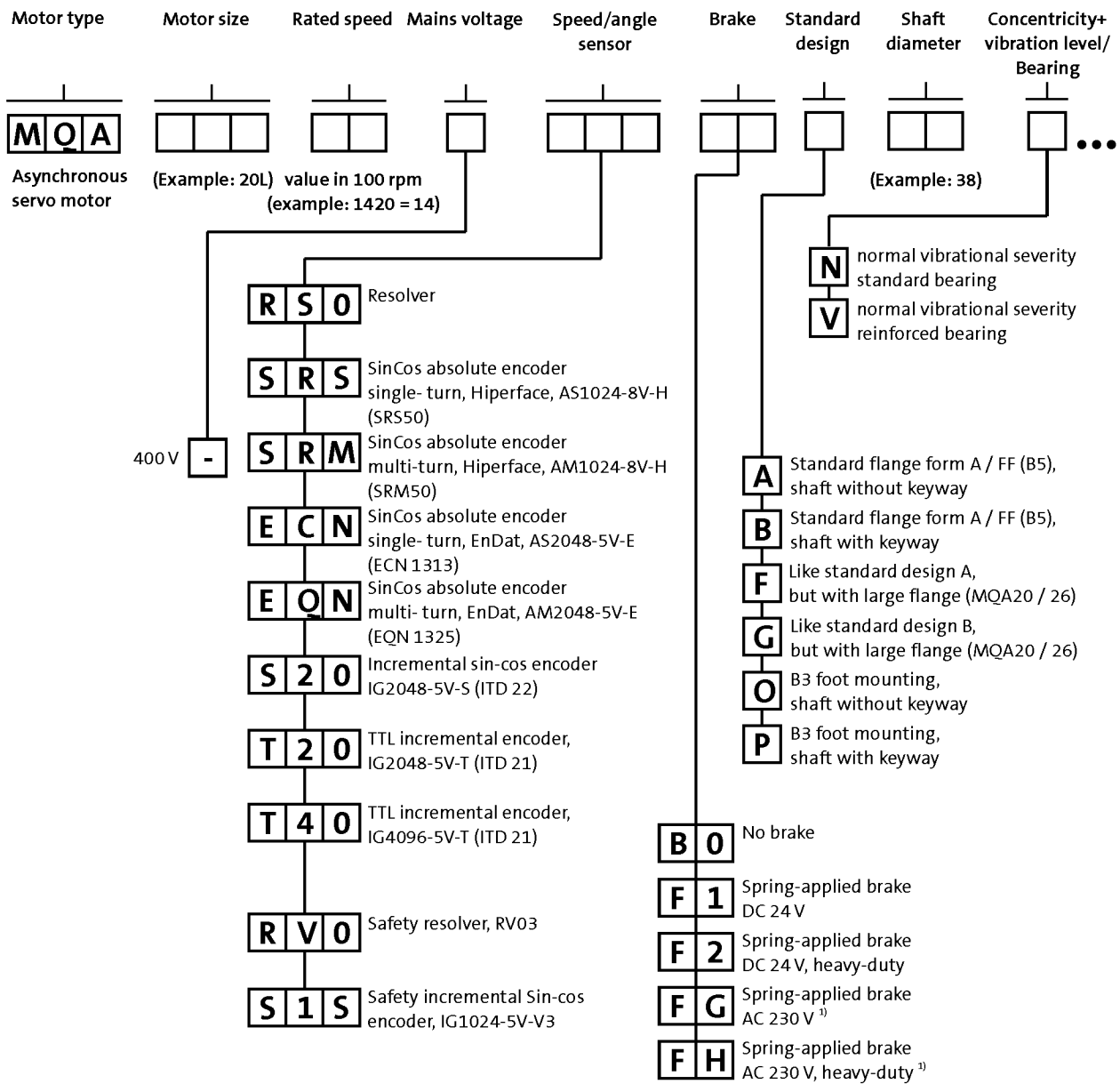

5.3

¹⁾ Not possible for UL design.

MQA asynchronous servo motors

General information



Product key

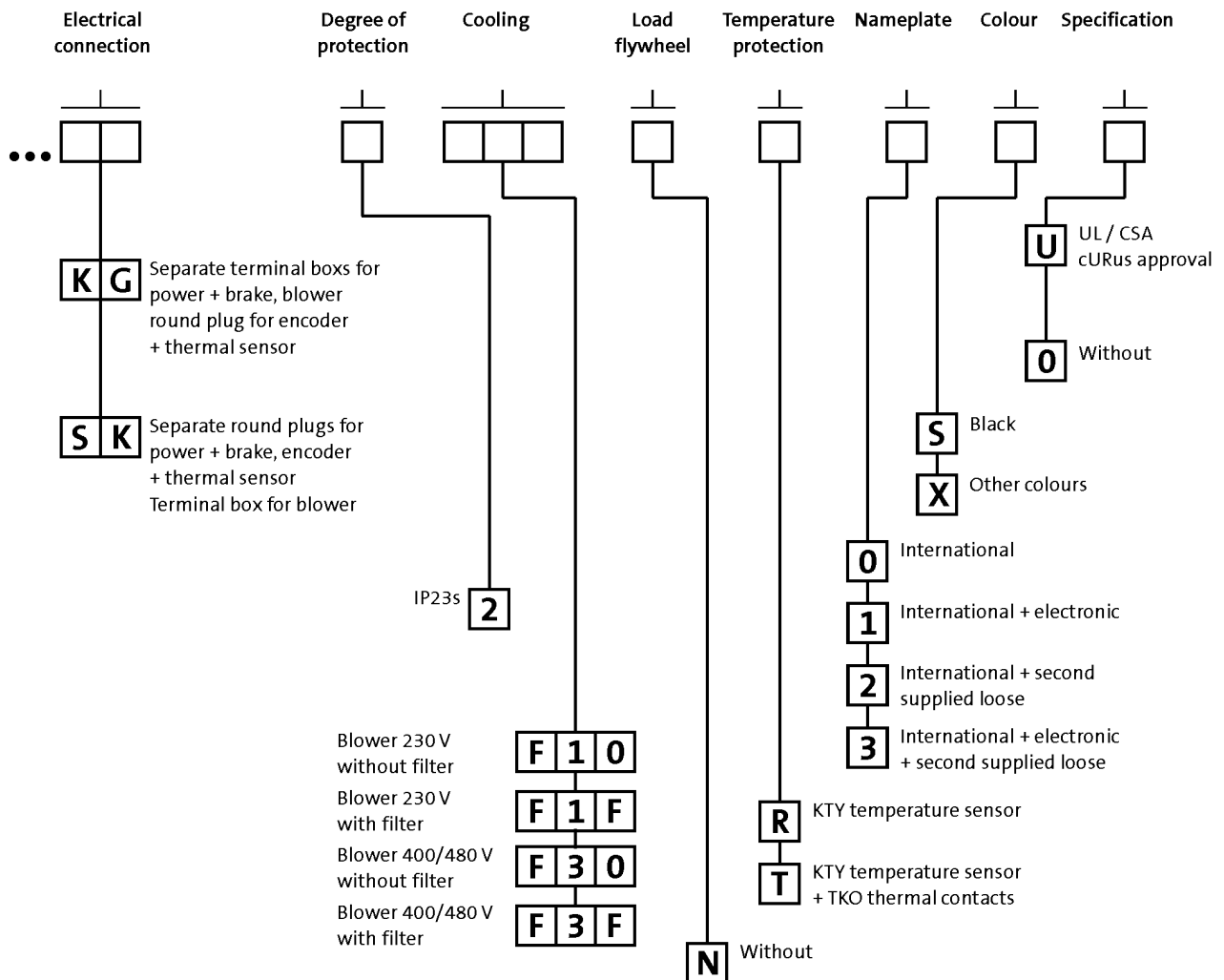

MQA asynchronous servo motors

General information



Product information

Designed for the harsh conditions of continuous operation in tight spaces at high torques, the enclosed-ventilated motors in the MDFQA series offer a long service life and optimum operational performance in all drive situations.

The motors, which have a power range of between 10 kW and 95 kW, are compact units with IP23 enclosure. They have been designed specifically for operation with Lenze's frequency and servo inverters. A wide range of feedback systems, brakes and blowers ensures that the perfect system configuration is available for virtually all operating conditions.

Advantages

- High power density
- Excellent operating characteristics
- IP23 protection
- Easy to install and service friendly
 - MQA 20 with SpeedTec connectors
 - MQA 22 and 26 with three-part terminal box
- Temperature class F
- KTY temperature monitoring
- Radial external fan
- B3 or B35 design
- Wide speed control range
- Field weakening operation usable

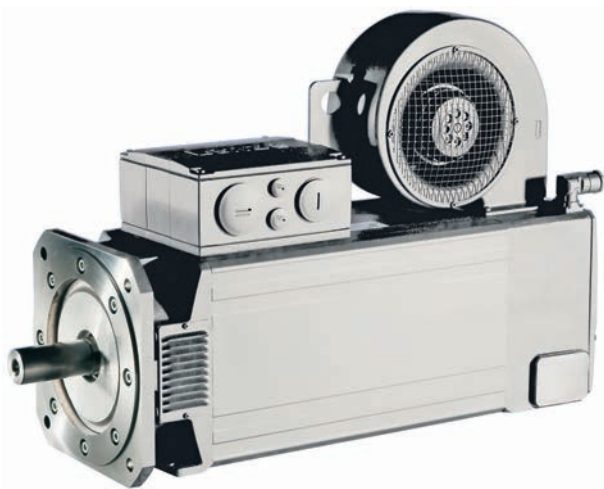

MQA22 asynchronous servo motor

MQA asynchronous servo motors

General information



Functions and features

	MQA20	MQA22	MQA26
Design			
	B3 B35-FF215 B35-FF265	B3 B35-FF265	B3 B35-FF265 B35-FF350
Shaft end (with and without keyway)	38 x 80		55 x 110
A end shield	Oil-tight Not oil-tight		
Brake			
Spring-applied brake	DC 24 V AC 230 V ^{1, 2)}		
Speed and angle encoder			
	Resolver SinCos single-turn/multi-turn Incremental encoder		
Cooling			
Radial blower, 1 phase	230 V; 50 Hz 230 V; 60 Hz		
Radial blower, 3 phase	400 V; 50 Hz 400 V; 60 Hz 460 V; 50 Hz 460 V; 60 Hz 480 V; 60 Hz		
Temperature sensor			
Thermal detector	KTY		
Thermal contact	TKO ³⁾		
Motor connection: Terminal box + plug connector			
Terminal box	Power + brake Blower		
Plug connector	Power + brake Encoder + thermal sensor	Encoder + thermal sensor	
Shaft bearings			
Bearing type	Deep-groove ball bearing with high-temperature resistant grease, sealing disc or cover plate		
Position of the locating bearing	Non-drive end		
Installation of the locating bearing	insulation		
Colour			
	Primed (grey) RAL9005M		

¹⁾ Not possible for UR version.

²⁾ Not possible for MQA motor type with circular connector for motor connection.

³⁾ Not possible for MQA motor type with circular connector for motor connection and brake.

MQA asynchronous servo motors

General information



Dimensioning

Speed-dependent safety functions

Single encoder concepts with resolvers

Servo motors can perform speed-dependent safety functions for safe speed and / or safe relative position monitoring in a drive system with the Servo Drives 9400. The SM301 safety module, which can be integrated in the Servo Drives 9400, is used to implement these functions. When planning systems/installations of this kind, the following must always be observed:

When using just one single feedback system in the environment of these safety applications, the applicable safety engineering standard IEC 61800-5-2 [Adjustable speed electrical power drive systems - Part: 5-2: Safety requirements - Functional] stipulates special requirements for the connection between feedback system and motor shaft. This is due to the fact that two-channel safety systems at this point in the mechanical system are actually designed as single-channel systems. If this mechanical connection is designed with considerable overdimensioning, the standard permits exclusion of the fault "encoder-shaft breakage" or "encoder-shaft slip". As such, acceleration limit values must not be exceeded for the individual drive solutions. You can find the limit values in the corresponding feedback data of the individual motor ranges.

Speed-dependent safety functions in connection with the SM301 safety module

For the following speed-dependent safety functions, the motor-feedback system combinations listed in the following table are available:

- Safe stop 1 (SS1)
- Safe operational stop (SOS)
- Safely Limited Speed (SLS)
- Safe Maximum Speed (SMS)
- Safe direction (SDI)
- Operation mode selector (OMS) with confirmation (ES)
- Safe speed monitor (SSM)
- Safely limited increment (SLI).

Encoder type	Encoder type	Product key	Feedback Design	Safe speed monitoring
SinCos incremental	Single-turn	IG1024-5V-V3	2-encoder concept	PL e/SIL 3 up to PL e / SIL 3
Resolver		RV03		

MQA asynchronous servo motors

General information



Dimensioning

Cooling effect of mounting flange

Mounting on a thermally conducting / insulating plate or machine chassis only has a minor impact in terms of heating up the motor when using servo motors from the MQA range. As such, this effect is negligible and can be disregarded.

Vibrational severity

		MQA20	MQA22	MQA26
Vibrational severity				
IEC/EN 60034-14			A	
Maximum r.m.s. value of the vibration velocity ¹⁾	[mm/s]		1.60	

¹⁾ Free suspension

- ▶ at n = 600 to 3,600 rpm



Dimensioning

Concentricity and axial run-out of the mounting flanges and smooth running of the shaft ends

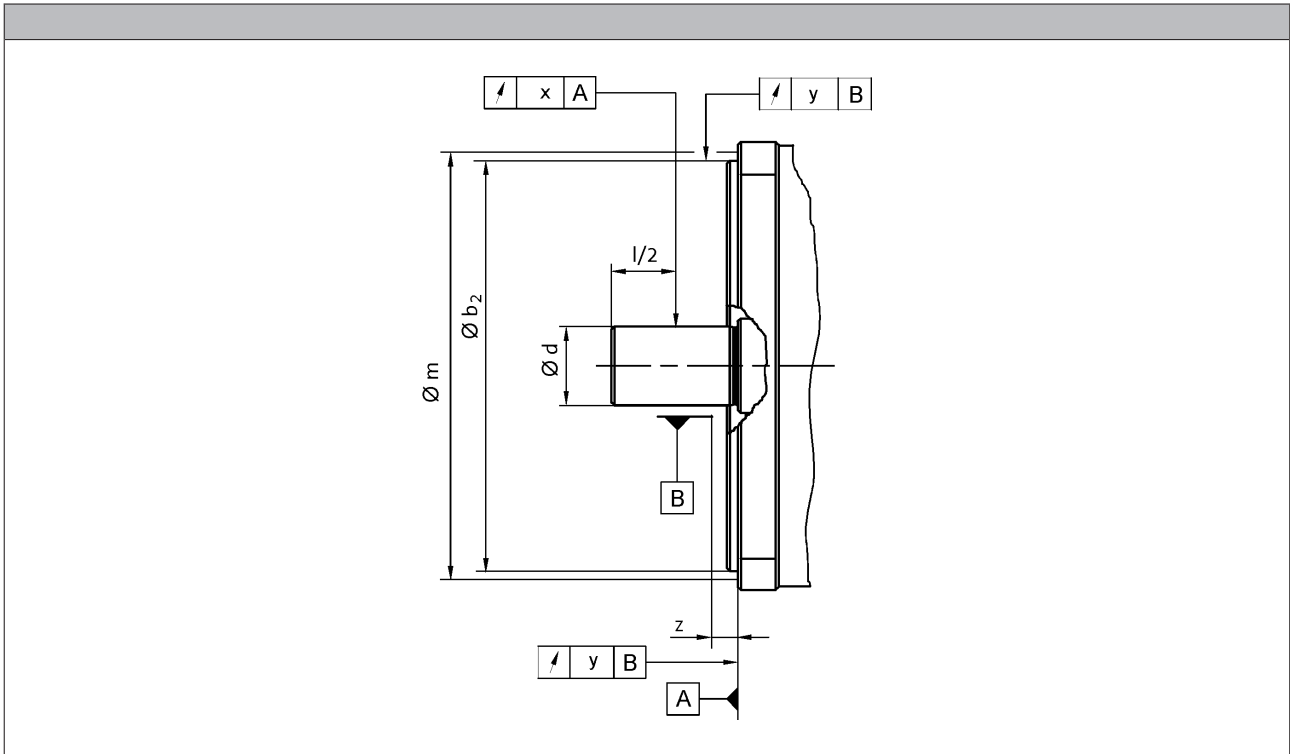

5.3

				MQA20	MQA22	MQA26
Flange size				FF215	FF265	FF350
Dimensions						
	b_2	j6	[mm]	180	230	
	b_2	h6	[mm]			300
	d	k6	[mm]	38		
	d	m6	[mm]			55
Distance						
Measuring diameter	m		[mm]	239	289	384
Dial gauge holder for flange check	z	+/- 1	[mm]	10.0		
Concentricity						
IEC 60072				Normal class		
Value	y		[mm]	0.10		
Linear movement						
IEC 60072				Normal class		
Value	y		[mm]	0.10		
Smooth running						
IEC 60072				Normal class		
Value	x		[mm]	0.050		0.060

- Limit values for checking the smooth running of the shaft ends as well as the concentricity and axial run-out of the mounting flange to IEC 60072

MQA asynchronous servo motors

General information



Dimensioning

Notes on the selection tables

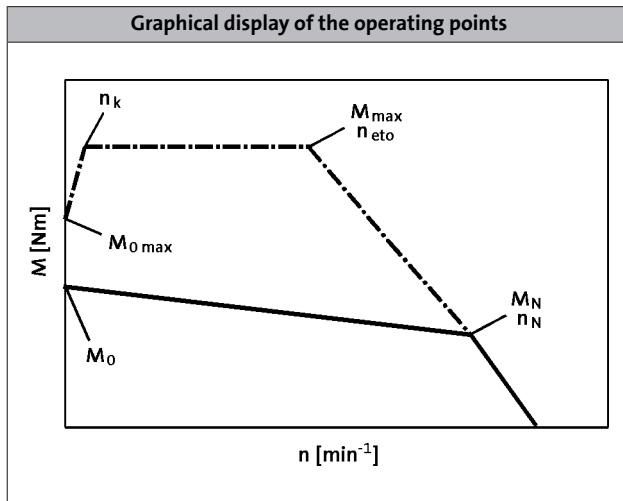

	n_k [r/min]
MCA	150
MQA	

Please note:

- With an active load (e.g. vertical drive axes, hoists, test benches, unwinders), $M_{0\max}$ must be taken into account
- With a passive load (e.g. horizontal drive axes), M_{\max} can generally be used
- At speeds $< n_k$, the inverter-specific torque $M_{0\max}$ that can be achieved is lower than M_{\max}
- On the servo inverters, the switching frequency-dependent overload capacity has been taken into account in the factory settings. For further information, please refer to the Servo-Inverters catalogue.

Further selection tables with different switching frequencies are available with the following codes:

- DS_ZT_MCS_0001
- DS_ZT_MCA_0001
- DS_ZT_MDSKS_0001
- DS_ZT_MDFKS_0001

Simply enter this code (e.g. DS_ZT_MCS_0001) as a search string at www.lenze.de/dsc and you will be given the information immediately in the form of a PDF format.



Dimensioning

Notes on the torque characteristics

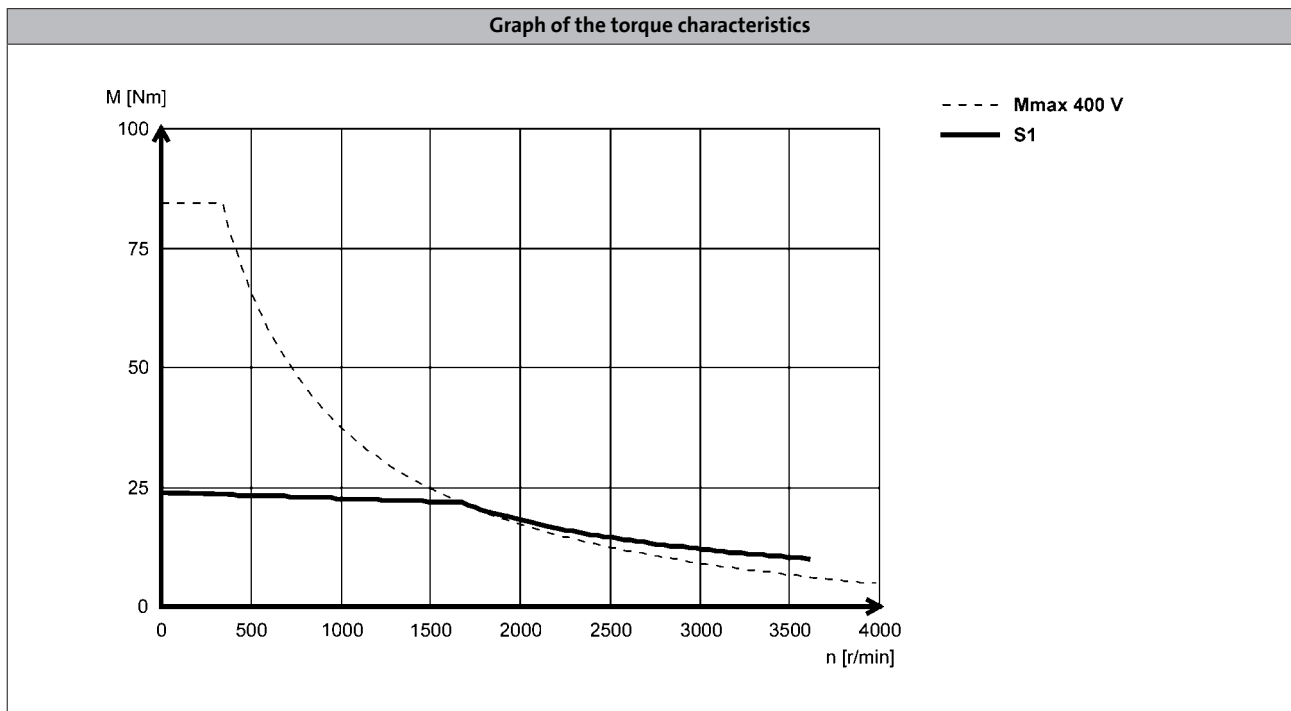

5.3

With asynchronous servo motors, two characteristics are shown in each case. The characteristics for continuous operation (S1) show the speed-dependent constant torque of the motor when operating with a servo inverter that itself is operated at a constant switching frequency. The limit torque characteristics correspond to those that come about during operation of the motor with the largest possible 9400 Servo Drive in each case (see selection tables). The servo inverter is set to a variable switching frequency here.

Characteristics in the Internet

You can find the torque characteristic for inverter-motor combinations on the Internet at www.lenze.de/dsc. This lists all useful combinations with the servo inverters 9400, 9300, ECS and Inverter Drives 8400 TopLine. These characteristics are each determined using the factory default settings of the inverters:

- 9400 with variable switching frequency.
This means that up to 6-fold overcurrent can be applied in borderline cases.
- 9300 and ECS with fixed switching frequency.
- 8400 TopLine with variable switching frequency.

The continuous operation characteristics (S1) show the inverter-independent motor rating values

Further information on the terms switching frequency and factory default settings can be found in the operating manual of the respective servo inverter.



Dimensioning

Influence of ambient temperature and site altitude

The information relating to the servo motors in the tables and graphs is valid for a maximum ambient temperature (T_{opr}) of 40 °C and a site altitude (H) up to 1000 m above sea level. The torque correction factor (k_{M1}) shall be applied to the S1 torque characteristic ($M_0...M_N$) in the event of differing installation conditions.

- The maximum permissible ambient temperature (T_{opr}) for servo motors with blowers is 40 °C

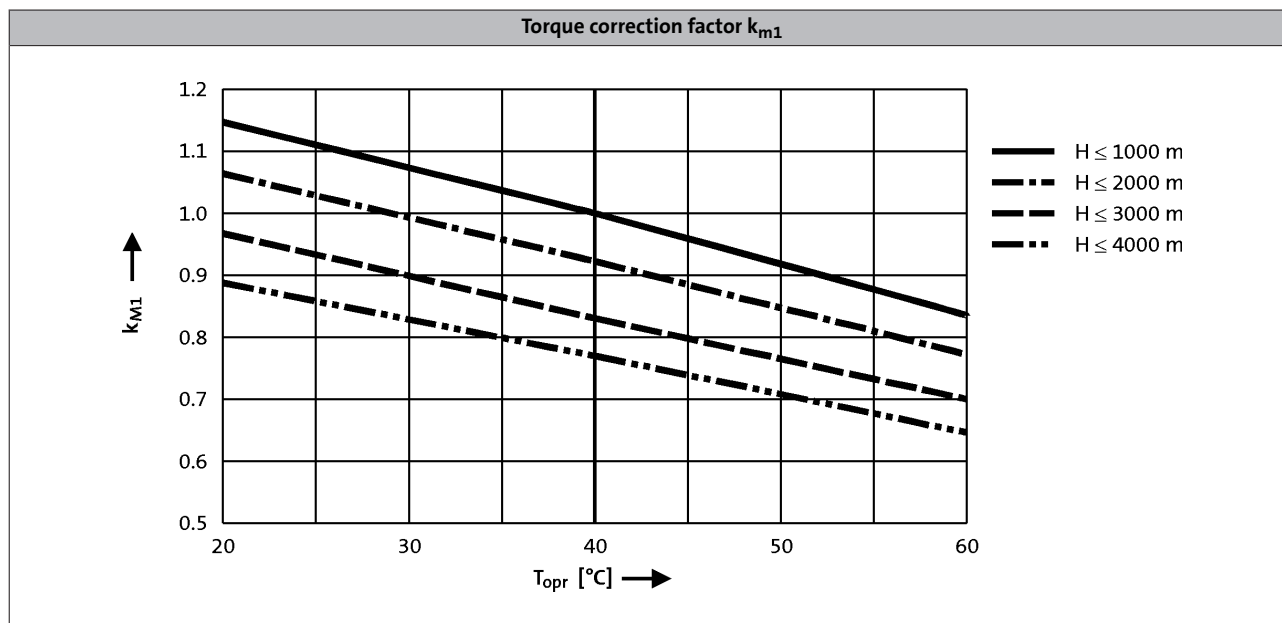

MQA asynchronous servo motors

General information



MQA asynchronous servo motors

Technical data



Standards and operating conditions

			MQA
Cooling type			Blower
Degree of protection			IP23s
EN 60529			
Temperature class			F
IEC/EN 60034-1; utilisation			
IEC/EN 60034-1; insulation system (enamel-insulated wire)			H
Approval			
Class			cURus ^{1, 2)} GOST-R UkrSepro
Max. voltage load			
IEC/TS 60034-25			Pulse voltage limiting curve A
Smooth running			
IEC 60072			Normal class
Linear movement			
IEC 60072			Normal class
Concentricity			
IEC 60072			Normal class
Mechanical ambient conditions (vibration)			
IEC/EN 60721-3-3			3M6
Min. ambient operating temperature			
Without brake	T _{opr,min}	[°C]	-15
With brake	T _{opr,min}	[°C]	-10
Max. ambient temperature for operation			
	T _{opr,max}	[°C]	40
Max. surface temperature			
	T	[°C]	110
Mechanical tolerance			
Flange centring diameter			b ₂ ≤ 230 mm = j6 b ₂ > 230 mm = h6
Shaft diameter			d ≤ 50 mm = k6 d > 50 mm = m6
Site altitude			
Amsl	H _{max}	[m]	4000

¹⁾ Recognized component File No. E 210321.

²⁾ MQA20L29 with circular connector for motor connection only UR



Permissible radial and axial forces

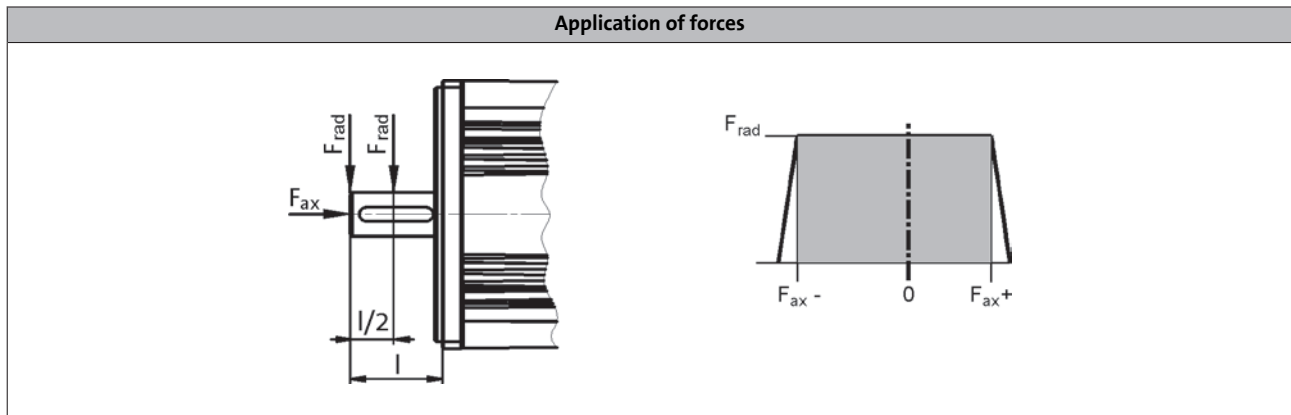

Application of force at l/2

	Bearing service life L_{10}														
	5000 h			10000 h			20000 h			30000 h			50000 h		
	F_{rad}	$F_{ax,-}$	$F_{ax,+}$	F_{rad}	$F_{ax,-}$	$F_{ax,+}$	F_{rad}	$F_{ax,-}$	$F_{ax,+}$	F_{rad}	$F_{ax,-}$	$F_{ax,+}$	F_{rad}	$F_{ax,-}$	$F_{ax,+}$
	[N]	[N]	[N]	[N]	[N]	[N]	[N]	[N]	[N]	[N]	[N]	[N]	[N]	[N]	[N]
MQA20	3400	-1330	690	2500	-1020	380	1950	-780	140	1700	-690	40			
MQA22	3600	-2370	1700	2800	-1740	1090	2200	-1280	640	1900	-1080	440	1600	-880	240
MQA26	6950	-2500	1580	5400	-1800	880	4300	-1300	380	3700	-1090	160			

Application of force at l

	Bearing service life L_{10}														
	5000 h			10000 h			20000 h			30000 h			50000 h		
	F_{rad}	$F_{ax,-}$	$F_{ax,+}$	F_{rad}	$F_{ax,-}$	$F_{ax,+}$	F_{rad}	$F_{ax,-}$	$F_{ax,+}$	F_{rad}	$F_{ax,-}$	$F_{ax,+}$	F_{rad}	$F_{ax,-}$	$F_{ax,+}$
	[N]	[N]	[N]	[N]	[N]	[N]	[N]	[N]	[N]	[N]	[N]	[N]	[N]	[N]	[N]
MQA20	3150	-1170	530	2300	-920	280	1800	-710	70	1400	-650	0			
MQA22	3500	-2240	1600	2600	-1640	1100	2050	-1200	560	1800	-1020	380	1450	-850	200
MQA26	6400	-2080	1150	5000	-1600	680	4000	-1160	230	3400	-1090	50			

- The values for the bearing service life L_{10} refer to an average speed of 3000 r/min. Depending on the ambient temperatures, the service life of the bearings is also reduced by the grease life-time.

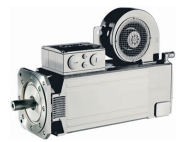

Permissible radial and axial forces

- Reinforced bearings

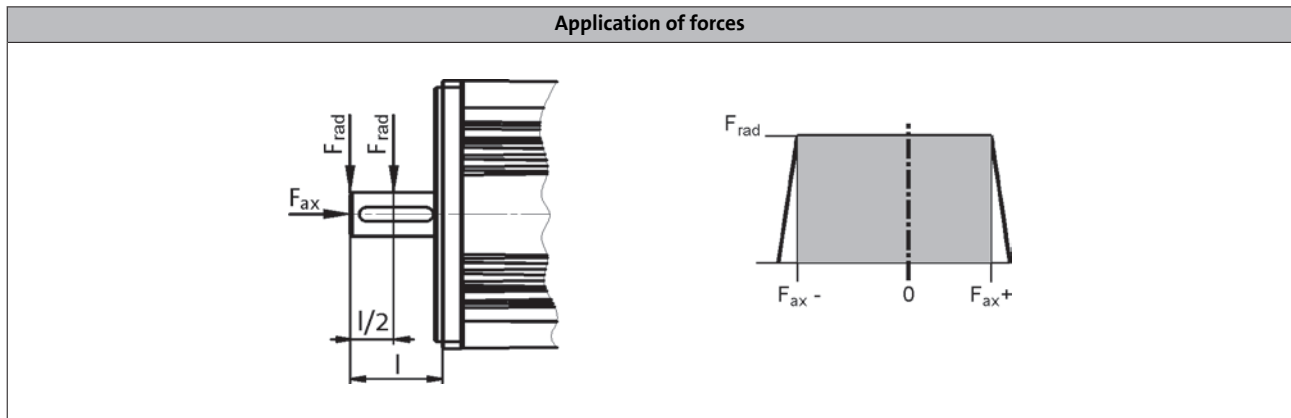

Application of force at $l/2$

	Bearing service life L_{10}														
	5000 h			10000 h			20000 h			30000 h			50000 h		
	F_{rad}	$F_{ax,-}$	$F_{ax,+}$	F_{rad}	$F_{ax,-}$	$F_{ax,+}$	F_{rad}	$F_{ax,-}$	$F_{ax,+}$	F_{rad}	$F_{ax,-}$	$F_{ax,+}$	F_{rad}	$F_{ax,-}$	$F_{ax,+}$
	[N]	[N]	[N]	[N]	[N]	[N]	[N]	[N]	[N]	[N]	[N]	[N]	[N]	[N]	[N]
MQA20	7100	-970	330	5100	-800	160	3900	-640	0						
MQA22	8500	-1850	1200	7000	-1400	760	5600	-1030	390	4350	-930	290	3200	-800	160
MQA26	10500	-2180	1250	8370	-1530	600	6670	-1130	200	5840	-960	30			

Application of force at l

	Bearing service life L_{10}														
	5000 h			10000 h			20000 h			30000 h			50000 h		
	F_{rad}	$F_{ax,-}$	$F_{ax,+}$	F_{rad}	$F_{ax,-}$	$F_{ax,+}$	F_{rad}	$F_{ax,-}$	$F_{ax,+}$	F_{rad}	$F_{ax,-}$	$F_{ax,+}$	F_{rad}	$F_{ax,-}$	$F_{ax,+}$
	[N]	[N]	[N]	[N]	[N]	[N]	[N]	[N]	[N]	[N]	[N]	[N]	[N]	[N]	[N]
MQA20	6350	-720	80	4100	-680	40	2800	-640	0						
MQA22	7000	-1750	1100	5500	-1300	660	4700	-920	280	3900	-820	180	3000	-700	60
MQA26	9600	-2200	1280	7700	-1280	360	6000	-960	30						

- The values for the bearing service life L_{10} refer to an average speed of 3000 r/min. Depending on the ambient temperatures, the service life of the bearings is also reduced by the grease life-time.



Rated data, forced ventilated

► The data applies to a mains connection voltage of 3 x 400 V.

	n_N [r/min]	M_0 [Nm]	M_N [Nm]	M_{max} [Nm]	P_N [kW]	I_0 [A]	I_N [A]	$U_{N, AC}$ [V]	f_N [Hz]	$J^{1)}$ [kgcm ²]	$\eta_{100\%}$ [%]
MQA20L14...2F□□	1420	76.0	71.3	250	10.6	27.0	26.5	360	50	171	80.0
MQA20L29...2F□□	2930	76.0	66.2	250	20.3	54.0	46.9	360	100	171	90.0
MQA22P08...2F□□	760	156	145	500	11.5	29.5	27.6	360	28	487	77.0
MQA22P14...2F□□	1425	156	135	500	20.1	51.0	45.6	360	50	487	86.0
MQA22P17...2F□□	1670	156	130	500	22.7	59.0	50.3	360	58	487	88.0
MQA22P29...2F□□	2935	156	125	500	38.4	102	86.0	360	100	487	90.0
MQA26T05...2F□□	550	325	296	1100	17.0	48.5	44.5	360	20	1335	81.0
MQA26T10...2F□□	1030	325	288	1100	31.1	85.5	76.2	360	36	1335	87.0
MQA26T12...2F□□	1200	325	282	1100	35.4	109	88.8	360	42	1335	82.0
MQA26T22...2F□□	2235	325	257	1100	60.2	171	138	340	76	1335	92.0

	R_1 [Ω]	$R_{UV\ 20\ ^\circ C}$ [Ω]	$R_{UV\ 150\ ^\circ C}$ [Ω]	R_2 [Ω]	$L_{1\sigma}$ [mH]	L [mH]	$L_{2\sigma}$ [mH]	$n_{max}^{2)}$ [r/min]	$m^{1)}$ [kg]
MQA20L14...2F□□	0.37	0.73	1.10	0.36	1.98	57.0	2.10	6500	63.0
MQA20L29...2F□□	0.090	0.18	0.28	0.090	0.49	13.7	0.52		
MQA22P08...2F□□	0.54	1.07	1.62	0.48	3.53	92.8	4.76		
MQA22P14...2F□□		0.36	0.54		3.57	93.3	4.81		
MQA22P17...2F□□	0.13	0.27	0.40	0.12	0.90	23.9	1.21		
MQA22P29...2F□□		0.080	0.12		0.89	23.2	1.20		
MQA26T05...2F□□	0.29	0.59	0.89	0.25	2.87	70.0	5.05	193	
MQA26T10...2F□□		0.20	0.30		2.91	69.2	5.09		
MQA26T12...2F□□	0.080	0.15	0.23	0.060	0.78	18.1	1.30		
MQA26T22...2F□□		0.050	0.075			18.4			

¹⁾ Without brake.

²⁾ Mechanically permissible maximum speed.

The data in the R_1 , $L_{1\sigma}$, L , R_2' and $L_{2\sigma}'$ columns is based on a single-phase equivalent circuit diagram at 20°C.

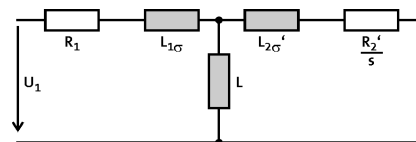

MQA asynchronous servo motors

Technical data



Selection tables, Servo Drives 9400 HighLine

Forced ventilated IP23s motors

- The data applies to a mains connection voltage of 3 x 400 V and an inverter switching frequency of 8 kHz.

					E94A□□	E0174	E0244	E0324	E0474	E0594	E0864	E1044	E1454	E1724
					I_N	16.5	23.5	32.0	41.0	41.0	73.0	78.0	102.0	120.0
					$I_{0,max}$	49.5	58.8	76.8	94.0	118.0	172.0	208.0	261.0	310.0
MQA	M_N	n_N	I_N	P_N	I_{max}	49.5	58.8	76.8	94.0	118.0	172.0	208.0	261.0	310.0
20L14-...2F□□	71.3	1420	26.5	10.60	M_0	32.5	66.0							
					M_N	32.5	66.0							
					$M_{0,max}$	154.2	190.0							
					M_{max}	154.2	190.0							
					η_{eto}	-	-							
20L29-...2F□□	66.2	2930	46.9	20.30	M_0			28.0	51.6	51.6				
					M_N			28.0	51.6	51.6				
					$M_{0,max}$			116.0	148.2	192.8				
					M_{max}			116.0	148.2	192.8				
					η_{eto}			-	-	-				
22P08-...2F□□	145.0	760	27.6	11.50	M_0		116.0	156.0						
					M_N		116.0	145.0						
					$M_{0,max}$		313.0	402.0						
					M_{max}		313.0	402.0						
					η_{eto}		-	-						
22P14-...2F□□	135.0	1425	45.6	20.10	M_0					118.0				
					M_N					118.0				
					$M_{0,max}$					372.0				
					M_{max}					372.0				
					η_{eto}					-				
22P17-...2F□□	130.0	1670	50.3	22.70	M_0					99.0	156.0			
					M_N					99.0	130.0			
					$M_{0,max}$					325.0	463.0			
					M_{max}					325.0	463.0			
					η_{eto}					-	-			
22P29-...2F□□	125.0	2935	86.0	38.40	M_0							109.0	156.0	156.0
					M_N							109.0	125.0	125.0
					$M_{0,max}$							335.0	416.0	486.0
					M_{max}							335.0	416.0	486.0
					η_{eto}							-	-	-

- $I...$ [A], $M...$ [Nm], $n...$ [r/min], $P...$ [kW]
- If the motors are operated at a lower switching frequency, please contact your Lenze sales office!
- When operating at 4 kHz, the motor generates just 95 % of its rated torque with increased noise emissions.

MQA asynchronous servo motors

Technical data



Selection tables, Servo Drives 9400 HighLine

Forced ventilated IP23s motors

- The data applies to a mains connection voltage of 3 x 400 V and an inverter switching frequency of 8 kHz.

					E94A□□	E0474	E0594	E0864	E1044	E1454	E1724	E2024	E2454	E2924	E3664
					I _N	41.0	41.0	73.0	78.0	102.0	120.0	131.0	160.0	191.0	240.0
					I _{0,max}	94.0	118.0	172.0	208.0	261.0	310.0	364.0	441.0	526.0	659.0
MQA	M _N	n _N	I _N	P _N	I _{max}	94.0	118.0	172.0	208.0	261.0	310.0	364.0	441.0	526.0	659.0
26T05- ...2F□□	296.0	550	44.5	17.00	M ₀	268.0	268.0	325.0							
					M _N	268.0	268.0	296.0							
					M _{0,max}	665.0	826.0	1100.0							
					M _{max}	665.0	826.0	1100.0							
					η _{eto}	-	-	-							
26T10- ...2F□□	288.0	1030	76.2	31.10	M ₀			270.0	298.0	325.0					
					M _N			270.0	288.0	288.0					
					M _{0,max}			713.0	855.0	1044.0					
					M _{max}			713.0	855.0	1044.0					
					η _{eto}			-	-	-					
26T12- ...2F□□	282.0	1200	88.8	35.40	M ₀				219.0	291.0	325.0	325.0			
					M _N				219.0	282.0	282.0	282.0			
					M _{0,max}				609.0	739.0	840.0	950.0			
					M _{max}				609.0	739.0	840.0	950.0			
					η _{eto}				-	-	-	-			
26T22- ...2F□□	257.0	2235	138.1	60.10	M ₀							242.0	290.0	325.0	325.0
					M _N							242.0	257.0	257.0	257.0
					M _{0,max}							711.0	843.0	1001.0	1100.0
					M _{max}							711.0	843.0	1001.0	1100.0
					η _{eto}							-	-	-	-

5.3

- I... [A], M... [Nm], n... [r/min], P... [kW]
- If the motors are operated at a lower switching frequency, please contact your Lenze sales office!
- When operating at 4 kHz, the motor generates just 95 % of its rated torque with increased noise emissions.

MQA asynchronous servo motors

Technical data



Selection tables, Inverter Drives 8400 TopLine

Forced ventilated IP23s motors

- The data applies to a mains connection voltage of 3 x 400 V and an inverter switching frequency of 8 kHz.

					E84AVTC	□1134	□1534	□1834	□2234	□3034	□3734	□4534	
					I_N	23.5	32.0	39.0	47.0	61.0	76.0	89.0	
					$I_{0,max}$	32.9	43.2	60.0	70.5	91.5	114.0	133.5	
MQA	M_N	n_N	I_N	P_N	I_{max}	47.0	64.0	78.0	94.0	122.0	152.0	178.0	
20L14-...2F□□	71.3	1420	26.5	10.60	M_0	-	76.0	76.0	76.0	76.0			
					M_N	-	71.3	71.3	71.3	71.3			
					$M_{0,max}$	146.0	202.0	249.2	250.0	250.0			
					M_{max}	146.0	202.2	249.2	250.0	250.0			
					η_{eto}	-	-	-	-	-			
20L29-...2F□□	66.2	2930	46.9	20.30	M_0			-	76.0	76.0	76.0	76.0	
					M_N			-	66.2	66.2	66.2	66.2	66.2
					$M_{0,max}$			121.8	140.9	183.7	224.5	250.0	
					M_{max}			121.8	140.9	183.9	225.5	250.0	
					η_{eto}			-	-	-	-	-	
22P08-...2F□□	145.0	760	27.6	11.50	M_0	-	156.0	156.0	156.0	156.0			
					M_N	-	144.5	144.5	144.5	144.5			
					$M_{0,max}$	222.8	310.5	377.0	372.9	374.6			
					M_{max}	223.0	310.5	377.0	372.9	374.6			
					η_{eto}	-	-	-	-	-			
22P14-...2F□□	135.0	1425	45.6	20.10	M_0		-	-	156.0	156.0	156.0	156.0	
					M_N			-	134.7	134.7	134.7	134.7	
					$M_{0,max}$			185.1	230.6	267.1	343.7	418.3	500.0
					M_{max}			185.1	230.6	267.1	344.4	420.0	500.0
					η_{eto}			-	-	-	-	-	-
22P17-...2F□□	130.0	1670	50.3	22.70	M_0			-	-	156.0	156.0	156.0	
					M_N			-	-	129.8	129.8	129.8	
					$M_{0,max}$			198.6	230.2	300.0	365.3	447.0	
					M_{max}			198.6	230.4	300.0	367.5	449.9	
					η_{eto}			-	-	-	-	-	
22P29-...2F□□	125.0	2935	86.0	38.40	M_0					-	-	156.0	
					M_N					-	-	124.9	
					$M_{0,max}$					176.1	218.9	263.2	
					M_{max}					176.4	219.6	264.1	
					η_{eto}					-	-	-	
26T05-...2F□□	296.0	550	44.5	17.00	M_0		-	-	325.0	325.0	325.0	325.0	
					M_N		-	-	295.2	295.2	295.2	295.2	
					$M_{0,max}$		390.4	489.6	567.1	744.4	902.3	1080.2	
					M_{max}		390.4	490.2	568.0	744.8	904.7	1080.2	
					η_{eto}		-	-	-	-	-	-	
26T10-...2F□□	288.0	1030	76.2	31.10	M_0							325.0	
					M_N							288.3	
					$M_{0,max}$					429.7	532.5	638.2	
					M_{max}					431.4	534.1	641.5	
					η_{eto}					-	-	-	

- $I...$ [A], $M...$ [Nm], $n...$ [r/min], $P...$ [kW]
- If the motors are operated at a lower switching frequency, please contact your Lenze sales office!

MQA asynchronous servo motors

Technical data



Selection tables, Inverter Drives 8400 TopLine

Forced ventilated IP23s motors

- ▶ The data applies to a mains connection voltage of 3 x 400 V and an inverter switching frequency of 8 kHz.

					E84AVTC	□1134	□1534	□1834	□2234	□3034	□3734	□4534
					I_N	23.5	32.0	39.0	47.0	61.0	76.0	89.0
					$I_{0,max}$	32.9	43.2	60.0	70.5	91.5	114.0	133.5
MQA	M_N	n_N	I_N	P_N	I_{max}	47.0	64.0	78.0	94.0	122.0	152.0	178.0
26T12- ...2F□□	282.0	1200	88.8	35.40	M_0						-	325.0
					M_N						-	281.7
					$M_{0,max}$						458.2	550.4
					M_{max}						460.6	552.9
					η_{eto}							

- ▶ $I...$ [A], $M...$ [Nm], $n...$ [r/min], $P...$ [kW]
- ▶ If the motors are operated at a lower switching frequency, please contact your Lenze sales office!

MQA asynchronous servo motors

Technical data



Selection tables, Servo Inverter 9300

Forced ventilated IP23s motors

- The data applies to a mains connection voltage of 3 x 400 V and an inverter switching frequency of 8 kHz.

					EVS	9326-E□	9327-E□	9328-E□	9329-E□	9330-E□	9331-E□	9332-E□
					I_N	23.5	32.0	47.0	59.0	89.0	110.0	145.0
					$I_{0,max}$	23.5	32.0	47.0	52.0	80.0	110.0	126.0
MQA	M_N	n_N	I_N	P_N	I_{max}	35.3	48.0	70.5	88.5	133.5	165.0	217.5
20L14-...2F□□	71.3	1420	26.5	10.60	M_0	61.0	76.0	76.0				
					M_N	61.0	71.3	71.3				
					$M_{0,max}$	61.0	112.0	187.0				
					M_{max}	109.3	156.7	232.1				
					η_{eto}	-	-	-				
20L29-...2F□□	66.2	2930	46.9	20.30	M_0		28.0	66.3	76.0	76.0		
					M_N		28.0	66.2	66.2	66.2		
					$M_{0,max}$		28.0	66.3	95.0	169.0		
					M_{max}		68.5	112.5	146.4	226.7		
					η_{eto}		-	-	-	-		
22P08-...2F□□	145.0	760	27.6	11.50	M_0		156.0	156.0	156.0			
					M_N		145.0	145.0	145.0			
					$M_{0,max}$		177.0	280.0	293.0			
					M_{max}		247.0	338.8	345.8			
					η_{eto}		-	-	-			
22P14-...2F□□	135.0	1425	45.6	20.10	M_0			146.0	156.0	156.0		
					M_N			135.0	135.0	135.0		
					$M_{0,max}$			146.0	186.0	188.0		
					M_{max}			230.1	292.9	341.8		
					η_{eto}			-	-	-		
22P17-...2F□□	130.0	1670	50.3	22.70	M_0			124.0	156.0	156.0	156.0	
					M_N			124.0	130.0	130.0	130.0	
					$M_{0,max}$			124.0	140.0	240.0	335.0	
					M_{max}			180.5	227.7	342.1	378.3	
					η_{eto}			-	-	-	-	
22P29-...2F□□	125.0	2935	86.0	38.40	M_0					135.5	156.0	156.0
					M_N					125.0	125.0	125.0
					$M_{0,max}$					137.0	195.0	250.0
					M_{max}					215.6	273.1	355.1
					η_{eto}					-	-	-
26T05-...2F□□	296.0	550	44.5	17.00	M_0			303.0	325.0	325.0		
					M_N			296.0	296.0	296.0		
					$M_{0,max}$			303.0	333.0	615.0		
					M_{max}			482.0	612.0	751.0		
					η_{eto}			-	-	-		
26T10-...2F□□	288.0	1030	76.2	31.10	M_0					319.0	325.0	
					M_N					288.0	288.0	
					$M_{0,max}$					300.0	440.0	
					M_{max}					552.0	671.0	
					η_{eto}					-	-	

- $I...$ [A], $M...$ [Nm], $n...$ [r/min], $P...$ [kW]
- If the motors are operated at a lower switching frequency, please contact your Lenze sales office!

MQA asynchronous servo motors

Technical data



Selection tables, Servo Inverter 9300

Forced ventilated IP23s motors

- The data applies to a mains connection voltage of 3 x 400 V and an inverter switching frequency of 8 kHz.

					EVS	9326-E□	9327-E□	9328-E□	9329-E□	9330-E□	9331-E□	9332-E□
					I_N	23.5	32.0	47.0	59.0	89.0	110.0	145.0
					$I_{0,max}$	23.5	32.0	47.0	52.0	80.0	110.0	126.0
MQA	M_N	n_N	I_N	P_N	I_{max}	35.3	48.0	70.5	88.5	133.5	165.0	217.5
26T12- ...2F□□	282.0	1200	88.8	35.40	M_0					284.0	325.0	325.0
					M_N					282.0	282.0	282.0
					$M_{0,max}$					258.0	327.0	397.0
					M_{max}					424.0	512.0	663.0
					η_{eto}					-	-	-
26T22- ...2F□□	257.0	2235	138.1	60.10	M_0						177.0	222.0
					M_N						177.0	257.0
					$M_{0,max}$						203.0	220.0
					M_{max}						315.0	432.0
					η_{eto}						-	-

- $I...$ [A], $M...$ [Nm], $n...$ [r/min], $P...$ [kW]
- If the motors are operated at a lower switching frequency, please contact your Lenze sales office!

MQA asynchronous servo motors

Technical data



Torque characteristics

- ▶ The data applies to a mains connection voltage of 3 x 400 V.
- ▶ You can find further torque characteristics at www.lenze.de/dsc.

MQA20L14...2F□□ (forced ventilated)

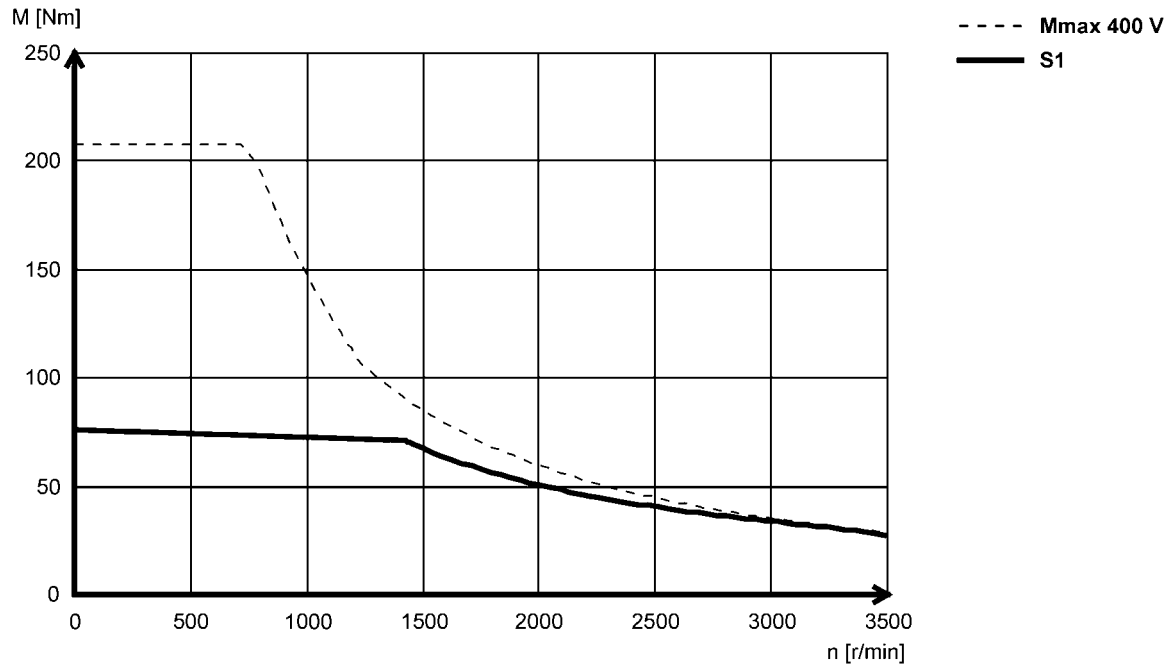

5.3

MQA20L29...2F□□ (forced ventilated)

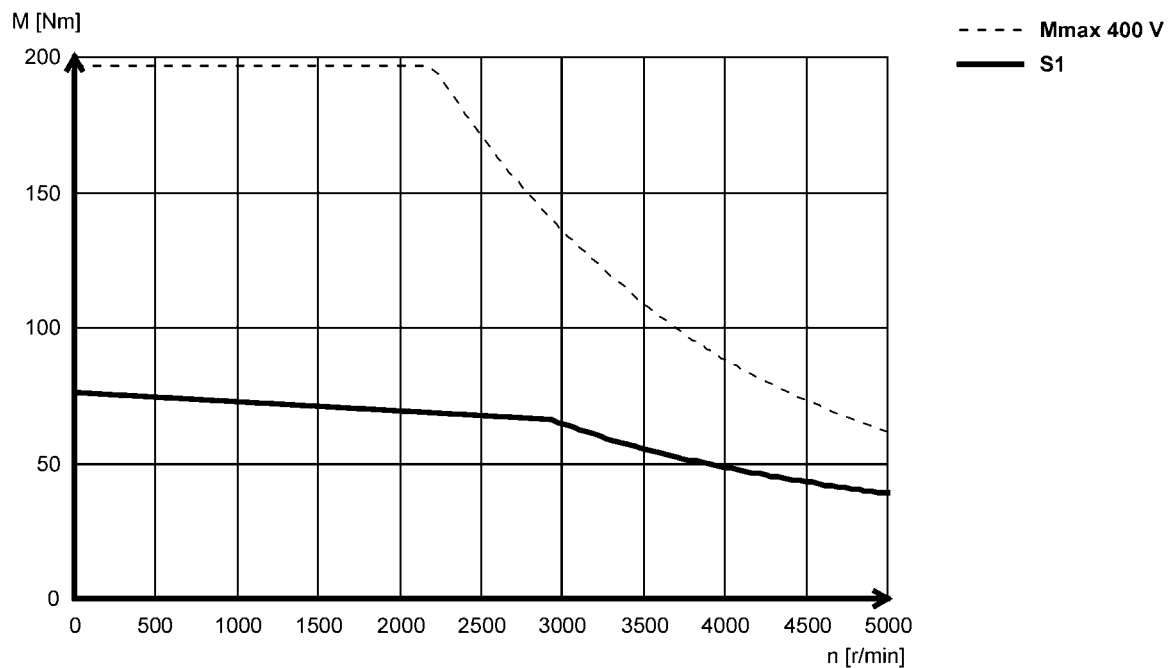

MQA asynchronous servo motors

Technical data



Torque characteristics

- ▶ The data applies to a mains connection voltage of 3 x 400 V.
- ▶ You can find further torque characteristics at www.lenze.de/dsc.

MQA22P08...2F□□ (forced ventilated)

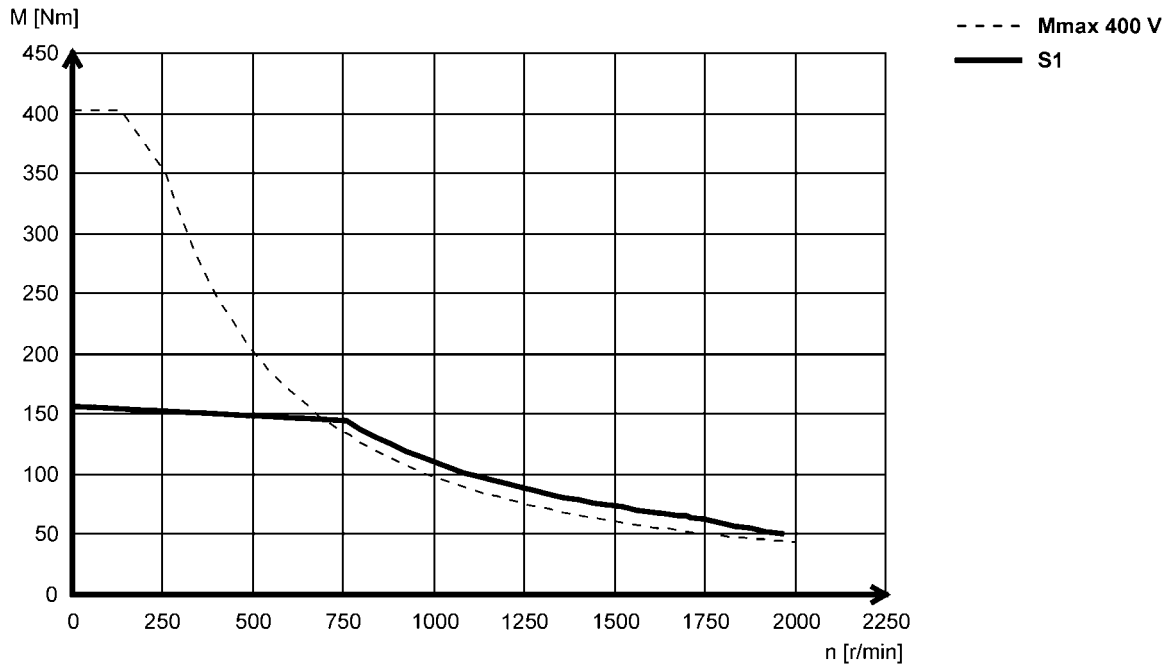

5.3

MQA22P14...2F□□ (forced ventilated)

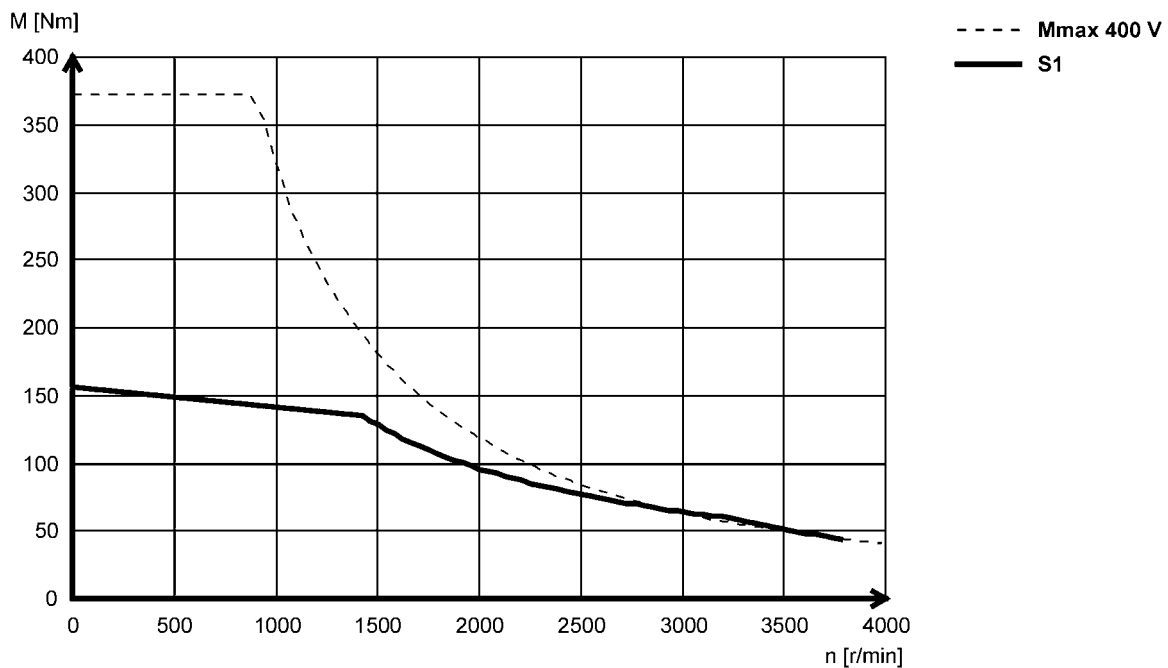

MQA asynchronous servo motors

Technical data



Torque characteristics

- ▶ The data applies to a mains connection voltage of 3 x 400 V.
- ▶ You can find further torque characteristics at www.lenze.de/dsc.

MQA22P17...2F□□ (forced ventilated)

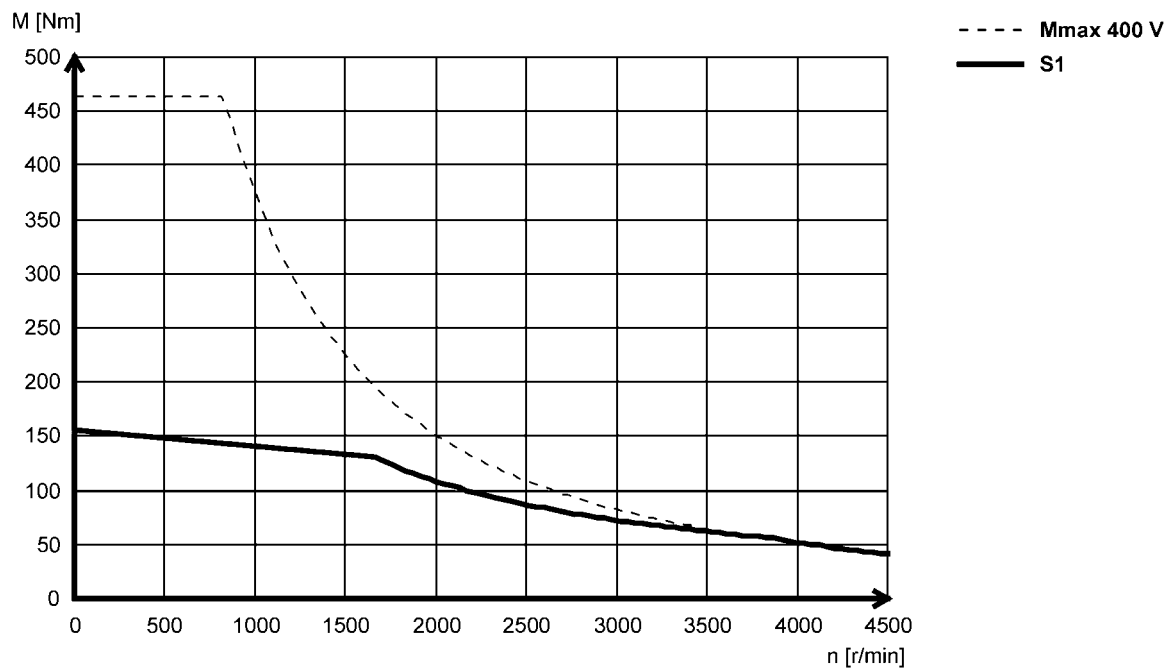

5.3

MQA22P29...2F□□ (forced ventilated)

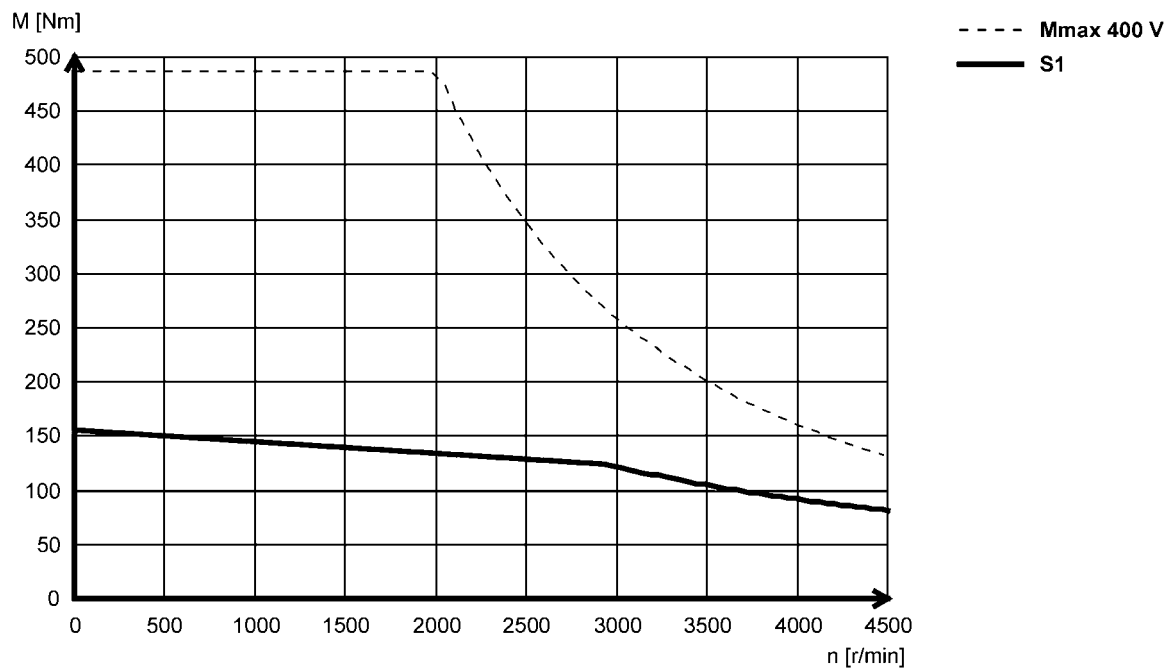

MQA asynchronous servo motors

Technical data



Torque characteristics

- ▶ The data applies to a mains connection voltage of 3 x 400 V.
- ▶ You can find further torque characteristics at www.lenze.de/dsc.

MQA26T05...2F□□ (forced ventilated)

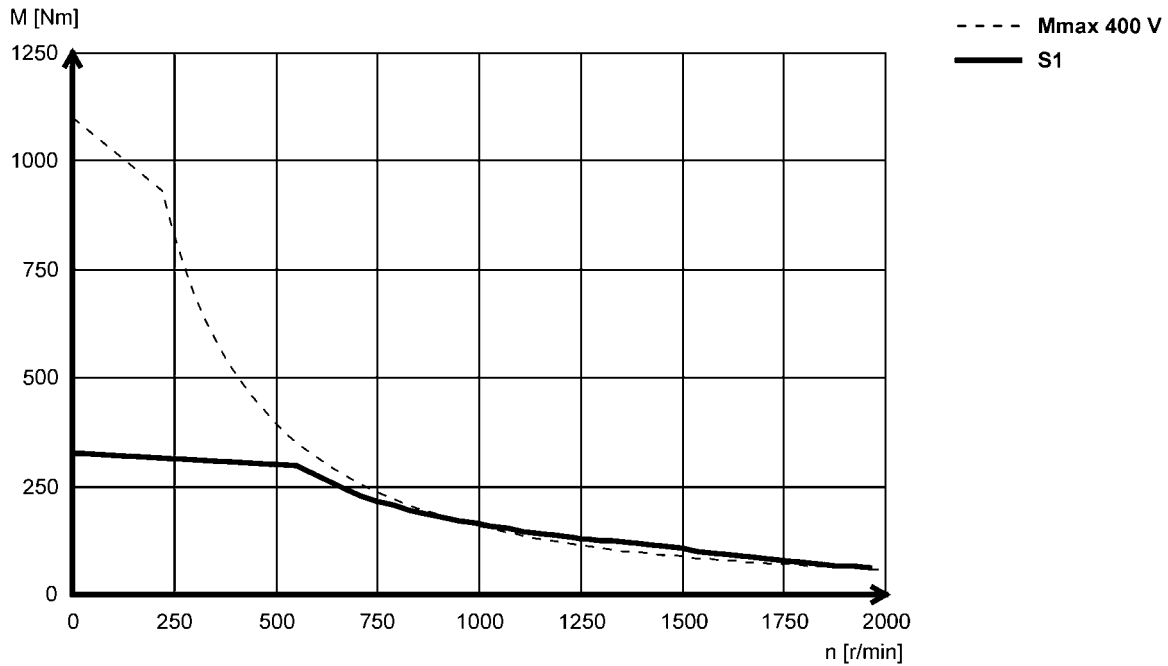

5.3

MQA26T10...2F□□ (forced ventilated)

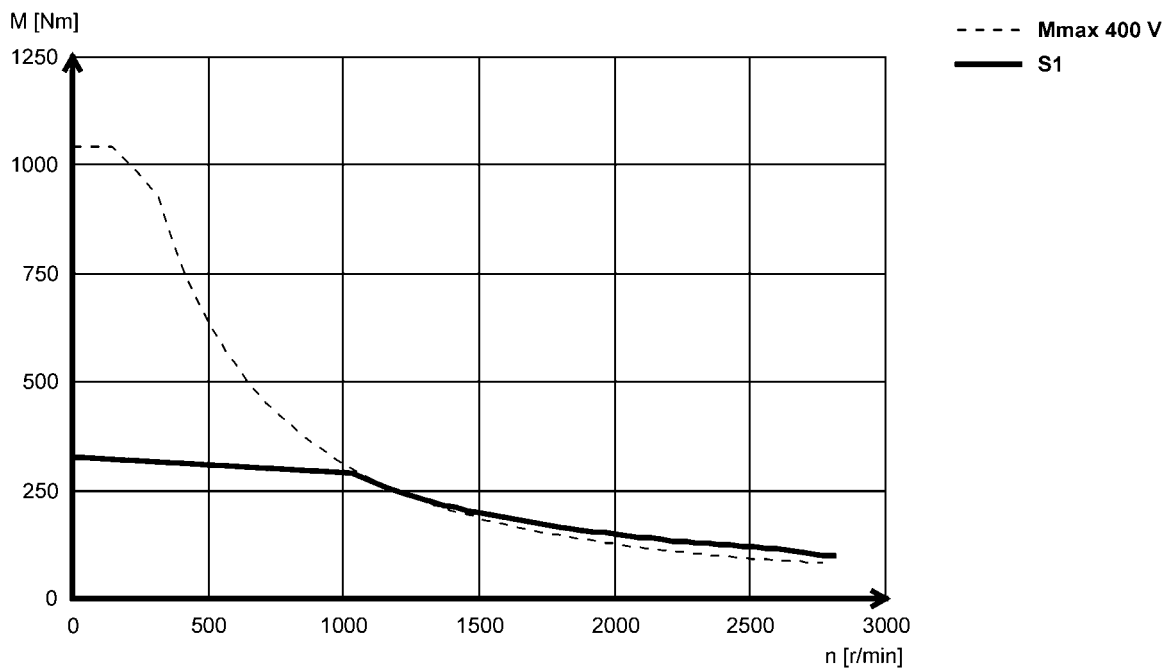

MQA asynchronous servo motors

Technical data



Torque characteristics

- ▶ The data applies to a mains connection voltage of 3 x 400 V.
- ▶ You can find further torque characteristics at www.lenze.de/dsc.

MQA26T12...2F□□ (forced ventilated)

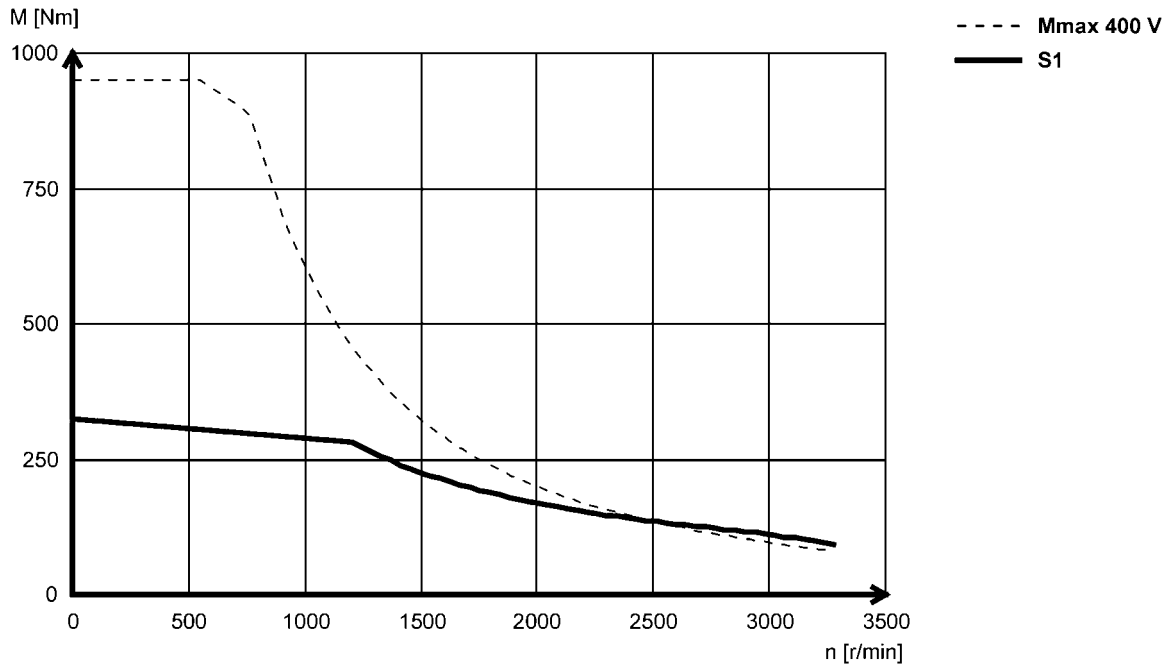

5.3

MQA26T22...2F□□ (forced ventilated)

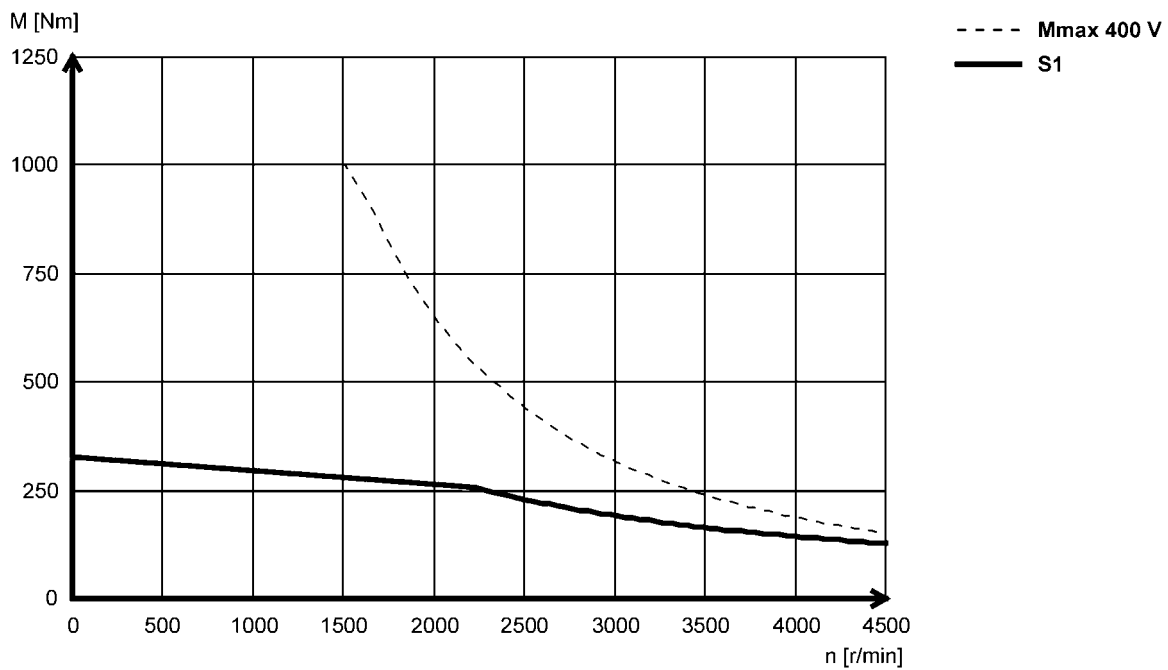

MQA asynchronous servo motors

Technical data



Dimensions, forced ventilated

Design B3

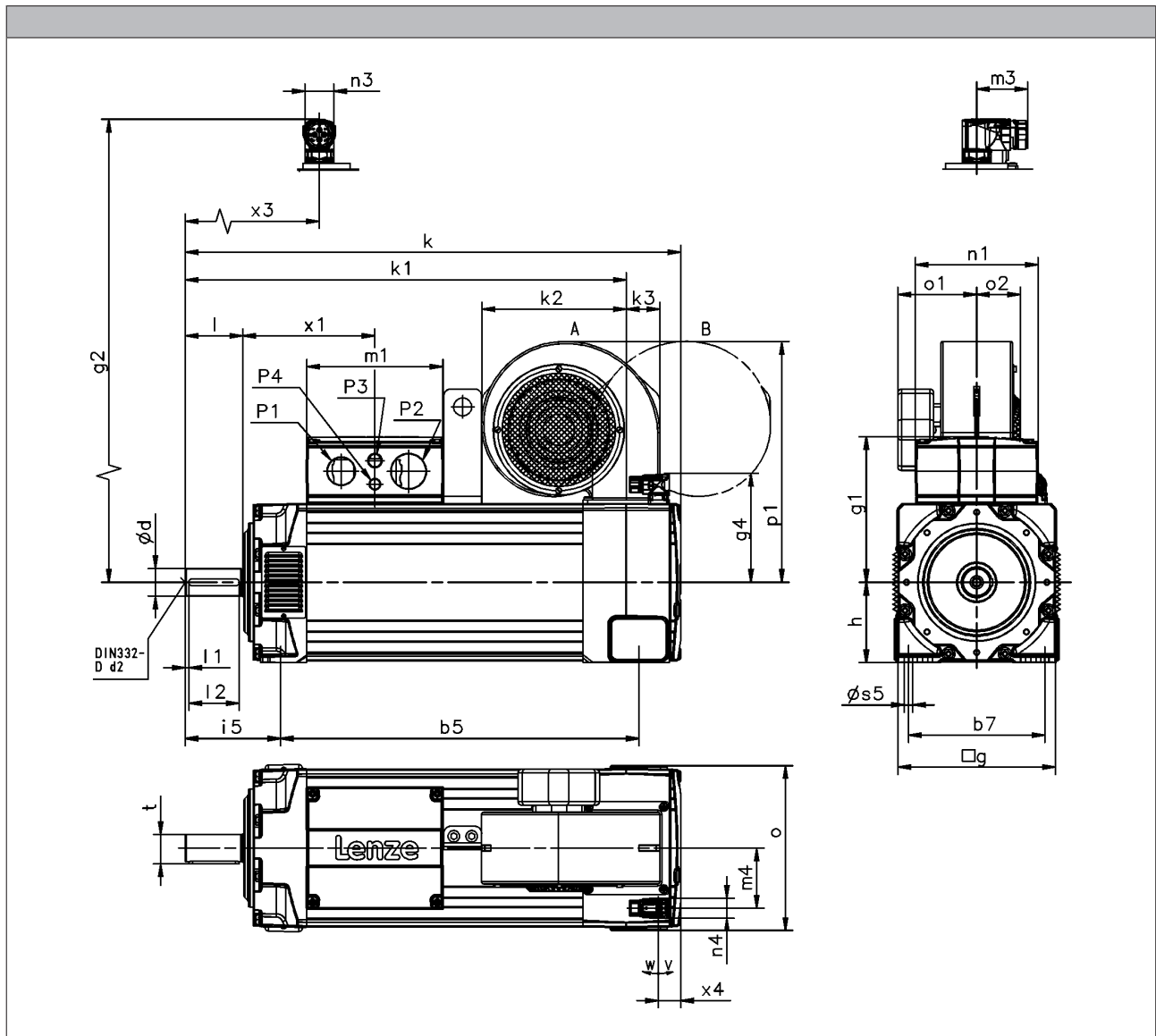

5.3

			MQA20	MQA22	MQA26
R□□ / E□□ / T□□ / S□□ / B0	k	[mm]	577	691	841
	x_4	[mm]	33.0	31.0	24.0
	m_4	[mm]	74.0	84.0	100
R□□ F1	k	[mm]	661	773	979
	x_4	[mm]	41.0	40.0	
	m_4	[mm]	70.0	76.0	96.0
E□□ / T□□ / S□□ / F1	k	[mm]	704	816	1017
	x_4	[mm]	46.0	45.0	40.0
	m_4	[mm]	70.0	76.0	96.0
R□□ / E□□ / T□□ / S□□ / F2	k	[mm]	729	848	1017
	x_4	[mm]	46.0	45.0	40.0
	m_4	[mm]	70.0	76.0	96.0

- ▶ Speed/angle sensor: R50 / S□□ / E□□ / T□□
- ▶ Brake: B0 / F1 / F2

MQA asynchronous servo motors

Technical data



Dimensions, forced ventilated

Design B3

	g	g ₁	g ₂	g ₄	m ₁	m ₃	n ₁	n ₃	n ₄
	[mm]	[mm]	[mm]	[mm]	[mm]	[mm]	[mm]	[mm]	[mm]
MQA20	200	171	168	141	154	72	128	40	28
MQA22	220	203		153	190		171		
MQA26	260	256		173	234		212		

	o	P ₁	P ₂	P ₃	P ₄	v	w	x ₁	x ₃
	[mm]	[mm]	[mm]	[mm]	[mm]	[°]	[°]	[mm]	[mm]
MQA20	206	M32x1.5	M25x1.5	M20x1.5		195	80	155	192
MQA22	230	M50x1.5	M40x1.5		M16x1.5			184	
MQA26	266	M63x1.5	M50x1.5		218				

	d	d	d ₂	l	l ₁	l ₂	u	t
	k6	m6		-0.7 ... 0.3				
	[mm]	[mm]	[mm]		[mm]	[mm]	[mm]	[mm]
MQA20	38		M12	80	5.0	70	10.0	41.0
MQA22								
MQA26		55	M20	110		100	16.0	59.0

	h	b ₅	b ₇	s ₅	i ₅
	[mm]	[mm]	[mm]	[mm]	[mm]
MQA20	100	386	160	11.5	134
MQA22	112	500	190		133
MQA26	132	605	215	14.0	165

	F10 / F30						F1F / F3F					
	k ₁	k ₂	k ₃	o ₁	o ₂	p ₁	k ₁	k ₂	k ₃	o ₁	o ₂	p ₁
	[mm]	[mm]	[mm]	[mm]	[mm]	[mm]	[mm]	[mm]	[mm]	[mm]	[mm]	[mm]
MQA20	498	152	32.0	118	47.0	276	498	152	32.0	118	124	276
MQA22	615	201	47.0	110	63.0	336	615	201	47.0	104	144	336
MQA26	764	221	60.0	125	86.0	391	764	221	60.0	120	140	391

5.3

MQA asynchronous servo motors

Technical data



Dimensions, forced ventilated

Design B35

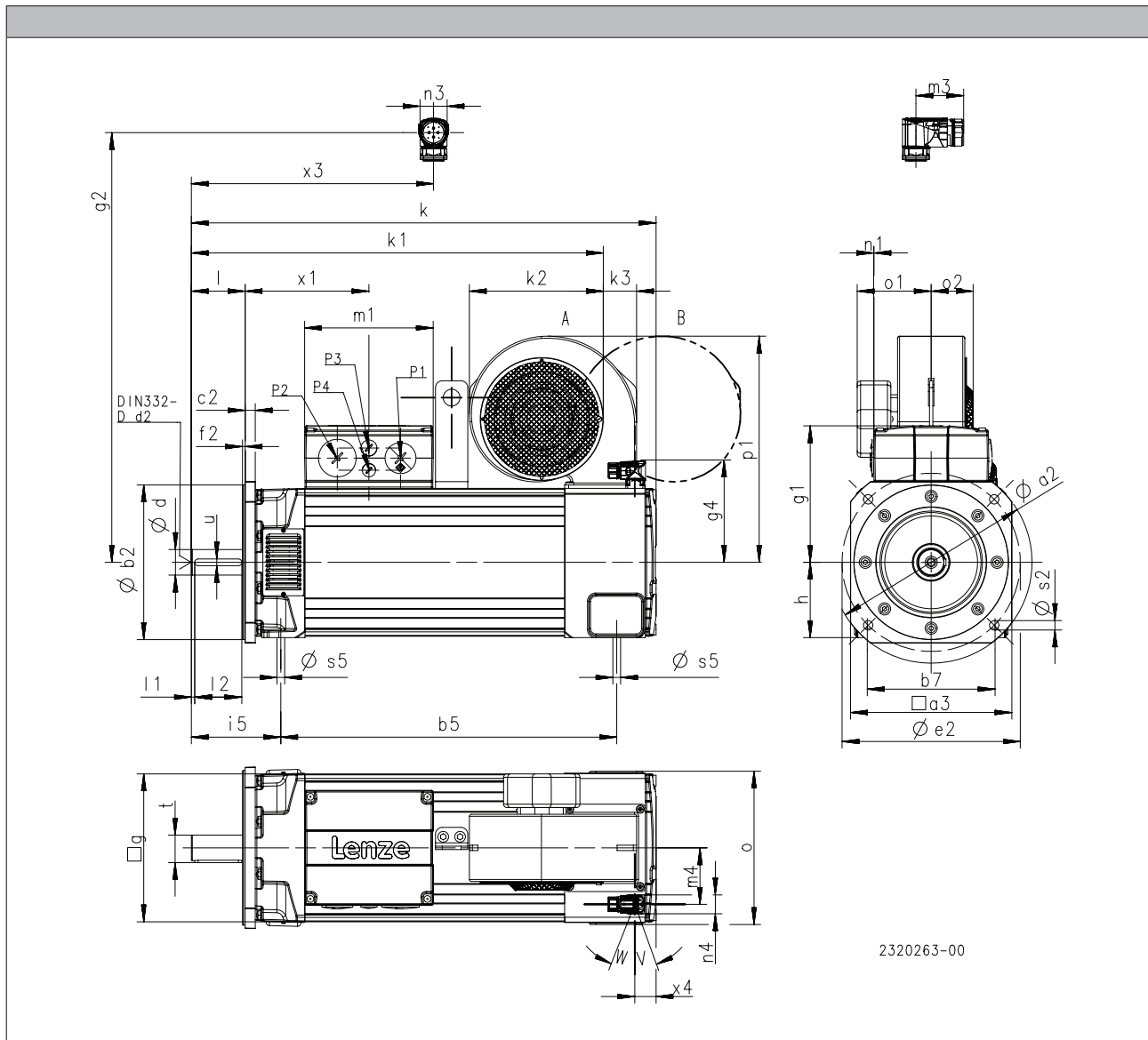

5.3

			MQA20	MQA22	MQA26
R□□ / E□□ / T□□ / S□□ / B0	k	[mm]	577	691	841
	x ₄	[mm]	33.0	31.0	24.0
	m ₄	[mm]	74.0	84.0	100
R□□ F1	k	[mm]	661	773	979
	x ₄	[mm]	41.0	40.0	
	m ₄	[mm]	70.0	76.0	96.0
E□□ / T□□ / S□□ / F1	k	[mm]	704	816	1017
	x ₄	[mm]	46.0	45.0	40.0
	m ₄	[mm]	70.0	76.0	96.0
R□□ / E□□ / T□□ / S□□ / F2	k	[mm]	729	848	1017
	x ₄	[mm]	46.0	45.0	40.0
	m ₄	[mm]	70.0	76.0	96.0

- ▶ Speed/angle sensor: RS0 / S□□ / E□□ / T□□
- ▶ Brake: B0 / F1 / F2

MQA asynchronous servo motors

Technical data



Dimensions, forced ventilated

Design B35

	g	g ₁	g ₂	g ₄	m ₁	m ₃	n ₁	n ₃	n ₄
	[mm]	[mm]	[mm]	[mm]	[mm]	[mm]	[mm]	[mm]	[mm]
MQA20	200	171	168	141	154	72	128	40	28
MQA22	220	203		153	190		171		
MQA26	260	256		173	234		212		

	o	P ₁	P ₂	P ₃	P ₄	v	w	x ₁	x ₃
	[mm]	[mm]	[mm]	[mm]	[mm]	[°]	[°]	[mm]	[mm]
MQA20	206	M32x1.5	M25x1.5	M20x1.5	M16x1.5	195	80	155	192
MQA22	230	M50x1.5	M40x1.5					184	
MQA26	266	M63x1.5	M50x1.5					218	

	d	d	d ₂	l	l ₁	l ₂	u	t
	k6	m6		-0.7 ... 0.3				
	[mm]	[mm]	[mm]		[mm]	[mm]	[mm]	[mm]
MQA20	38		M12	80	5.0	70	10.0	41.0
MQA22								
MQA26		55	M20	110		100	16.0	59.0

	h	b ₅	b ₇	s ₅	i ₅
	[mm]	[mm]	[mm]	[mm]	[mm]
MQA20	100	386	160	11.5	134
MQA22	112	500	190		133
MQA26	132	605	215	14.0	165

	a ₂	a ₃	b ₂	b ₂	c ₂	e ₂	f ₂	s ₂
			j6	h6				
	[mm]	[mm]	[mm]	[mm]	[mm]	[mm]	[mm]	[mm]
MQA20	250	196	180		15	215	4.0	14
MQA22	300	240	230			265		
MQA26	400	320		300		350	5.0	18

	F10 / F30						F1F / F3F					
	k ₁	k ₂	k ₃	o ₁	o ₂	p ₁	k ₁	k ₂	k ₃	o ₁	o ₂	p ₁
	[mm]	[mm]	[mm]	[mm]	[mm]	[mm]	[mm]	[mm]	[mm]	[mm]	[mm]	[mm]
MQA20	498	152	32.0	118	47.0	276	498	152	32.0	118	124	276
MQA22	615	201	47.0	110	63.0	336	615	201	47.0	104	144	336
MQA26	764	221	60.0	125	86.0	391	764	221	60.0	120	140	391

MQA asynchronous servo motors

Technical data





Spring-applied holding brake

The servo motors can be equipped with spring-operated holding brakes.

The brakes are activated when the supply voltage is disconnected (closed-circuit principle). When using the brakes purely as holding brakes, virtually no wear occurs on the friction surfaces.

Caution:

The brakes used are not safety brakes in the sense that a reduction in torque may arise as a result of disruptive factors that cannot be influenced, e.g. oil ingress.

The ohmic voltage drop along the cable must be taken into consideration in long motor supply cables and must be compensated for by a higher voltage at the line input.

The following applies for Lenze system cables:

$$U[V] = U_B[V] + 0.08 \frac{[V]}{[A] \cdot [m]} \cdot l_{lg}[m] \cdot I_B[A]$$

If no suitable voltage (incorrect value, incorrect polarity) is applied to the brake, the brake will be applied and can be overheated and destroyed by the motor continuing to rotate.

The shortest switching times of the brakes are achieved by DC switching of the voltage. A spark suppressor is required to suppress interference and to increase the service life of the relay contacts here.



Spring-applied holding brake



Spring-applied holding brake

Rated data with standard braking torque

- The figures stated apply to servo motors. They only apply to geared servo motors when the servo motor is connected via a mounting flange.

	$U_{N,DC}^{3,6)}$	$U_{N,AC}^{4,6)}$	M_N	M_N	M_{av}	$I_N^{2)}$	J	$t_1^{1)}$	$t_2^{1)}$	$Q_E^{5)}$	m	J_{MB}	J_L/J_{MB}
	[V]	[V]	[Nm]	[Nm]	[Nm]	[A]	[kgcm ²]	[ms]	[ms]	[J]	[kg]	[kgcm ²]	
MQA20	24	230	90.0	80.0	50.0	3.13	6.88	70.0	220	18000	13.0	177	19.6
	0.37												
MQA22	24	230	150	130	80.0	3.75	18.1	50.0	260	23000	20.5	505	8.20
	0.44					130							
MQA26	24	230	300	260	200	3.13	70.4	175	320	51000	30.7	1405	12.7
	0.37					360							

Rated data with increased braking torque

- The figures stated apply to servo motors. They only apply to geared servo motors when the servo motor is connected via a mounting flange.

	$U_{N,DC}^{3,6)}$	$U_{N,AC}^{4,6)}$	M_N	M_N	M_{av}	$I_N^{2)}$	J	$t_1^{1)}$	$t_2^{1)}$	$Q_E^{5)}$	m	J_{MB}	J_L/J_{MB}
	[V]	[V]	[Nm]	[Nm]	[Nm]	[A]	[kgcm ²]	[ms]	[ms]	[J]	[kg]	[kgcm ²]	
MQA20	24	230	150	130	100	2.58	14.1	70.0	240	31000	15.4	185	33.0
	0.30												
MQA22	24	230	300	260	160	3.75	36.3	175	310	39000	26.0	523	14.1
	0.44												
MQA26	24	230	500	430	260	3.75	70.4	175	390	51000	30.8	1405	12.7
	0.44												

- 1) Engagement and disengagement times are valid for rated voltage ($\pm 0\%$) and protective circuit for brakes with varistor for DC switching. The times may increase without a protective circuit.
- 2) The currents are the maximum values when the brake is cold (value used for dimensioning the current supply). The values for a motor at operating temperature are considerably lower.
- 3) With 24V DC brake: smoothed DC voltage, ripple $\leq 1\%$.
- 4) UR not possible in the case of a brake with 230 V supply voltage.
- 5) Maximum switching energy per emergency stop at $n = 3000$ r/min for at least 2000 emergency stops.
- 6) Voltage tolerance: permanent magnet brakes -10% to +5%
spring-applied brakes $\pm 10\%$



Resolver

Stator-fed resolver with two stator windings offset by 90° and one rotor winding with transformer winding.

Speed/angle sensor				RS0	RV0
	1)				
Product key				RS0	RV03
Resolution					
Angle			[°]	0.80	
Accuracy			[°]	-10 ... 10	
Absolute positioning				1 revolution	
Max. speed					
	n_{max}		[r/min]	8000	
Max. input voltage					
DC	$U_{in,max}$		[V]	10.0	
Max. input frequency					
	$f_{in,max}$		[Hz]	4.00	
Ratio					
Stator / rotor			± 5 %	0.30	
Rotor impedance					
	Z_{r0}		[Ω]	51 + j90	
Stator impedance					
	Z_{s0}		[Ω]	102 + j150	
Impedance					
	Z_{rs}		[Ω]	44 + j76	
Min. insulation resistance					
At DC 500 V	R		[Ω]	10.0	
Number of pole pairs				1	
Max. angle error					
			[°]	-10 ... 10	
Inverter assignment					
				E84AVTC E94A ECS EVS93	

1) 6 - Product key > speed/angle sensor

Speed-dependent safety functions

Suitable for safety function				No	Yes
Max. permissible angular acceleration					
MQA20 ... MQA26 ²⁾	α		[rad/s ²]		22 000
Functional safety					
IEC 61508					SIL3
EN 13849-1					Up to Performance Level e

2) 1 - Single encoder concepts with resolvers



Incremental encoder and SinCos absolute value encoder

Encoder type			TTL incremental		SinCos incremental	
Speed/angle sensor			T20	T40	S20	S15
Product key			IG2048-5V-T	IG4096-5V-T	IG2048-5V-S	IG1024-5V-V3
Encoder type			Single-turn			
Pulses			2048	4096	2048	1024
Output signals			TTL		1 V _{SS}	
Interfaces			A, B, N track and inverted			
Absolute revolutions			0			
Resolution						
Angle ²⁾		[°]	2.60	1.30	0.40	
Accuracy		[°]	-2 ... 2		-0.8 ... 0.8	
Min. input voltage						
DC	U _{in,min}	[V]	4.75		4.50	4.75
Max. input voltage						
DC	U _{in,max}	[V]	5.25		5.50	5.25
Max. speed						
	n _{max}	[r/min]	8789		5273	8000
Max. current consumption						
	I _{max}	[A]	0.15		0.10	0.070
Limit frequency						
	f _{max}	[kHz]	300		180	200
Inverter assignment			E84AVTC E94A ECS EVS93			E94A

¹⁾ 6 - Product key > speed/angle sensor

²⁾ Inverter-dependent.



Speed-dependent safety functions

Suitable for safety function			No	No	No	Yes
Max. permissible angular acceleration						
MQA20 ... MQA26	α	[rad/s ²]				73 000
Functional safety						
IEC 61508						SIL3
EN 13849-1						Up to Performance Level e



Incremental encoder and SinCos absolute value encoder

Encoder type			SinCos absolute value			
Speed/angle sensor			SRS	SRM	ECN	EQN
Product key			AS1024-8V-H	AM1024-8V-H	AS2048-5V-E	AM2048-5V-E
Encoder type			Single-turn	Multi-turn	Single-turn	Multi-turn
Pulses			1024		2048	
Output signals			1 Vss			
Interfaces			Hiperface		EnDat	
Absolute revolutions			1	4096	1	4096
Resolution			0.40			
Angle			[°]			
Accuracy			-0.8 ... 0.8		-0.6 ... 0.6	
Min. input voltage						
DC	$U_{in,min}$	[V]	7.00		4.75	
Max. input voltage						
DC	$U_{in,max}$	[V]	12.0		5.25	
Max. speed						
	n_{max}	[r/min]	6000		12000	
Max. current consumption						
	I_{max}	[A]	0.080		0.15	0.25
Limit frequency						
	f_{max}	[kHz]	200			
Inverter assignment			E84AVTC E94A ECS EVS93		E94A	

1)   6 - Product key > speed/angle sensor

MQA asynchronous servo motors

Accessories



Blowers

Rated data for 50 Hz

		Degree of protection	Number of phases	U_{\min}	U_{\max}	$U_{N,AC}$	P_N	I_N
				[V]	[V]	[V]	[kW]	[A]
MQA20	F10 F1F	IP23s	1	210	250	230	0.090	0.39
	F30 F3F		3	360	440	400	0.067	0.13
MQA22	F10 F1F		1	210	250	230	0.26	1.10
	F30 F3F		3	360	440	400	0.23	0.37
MQA26	F30 F3F						0.43	0.68

Rated data for 60 Hz

		Degree of protection	Number of phases	U_{\min}	U_{\max}	$U_{N,AC}$	P_N	I_N
				[V]	[V]	[V]	[kW]	[A]
MQA20	F10 F1F	IP23s	1	210	250	230	0.12	0.49
	F30 F3F		3	440	520	480	0.10	0.16
MQA22	F10 F1F		1	210	250	230	0.30	1.28
	F30 F3F		3	440	520	480	0.37	0.48
MQA26	F30 F3F						0.60	0.79

5.3



Temperature monitoring

The thermal sensors (1x KTY 83-110) used continuously monitor the motor temperature. The temperature signal is transmitted over the system cable of the feedback system to the servo controller. This means that the temperature of the motor is determined with great accuracy in the permitted operating range and at the same time the overtemperature response configured in the controller is executed in the event of overtemperature in one of the winding phases.

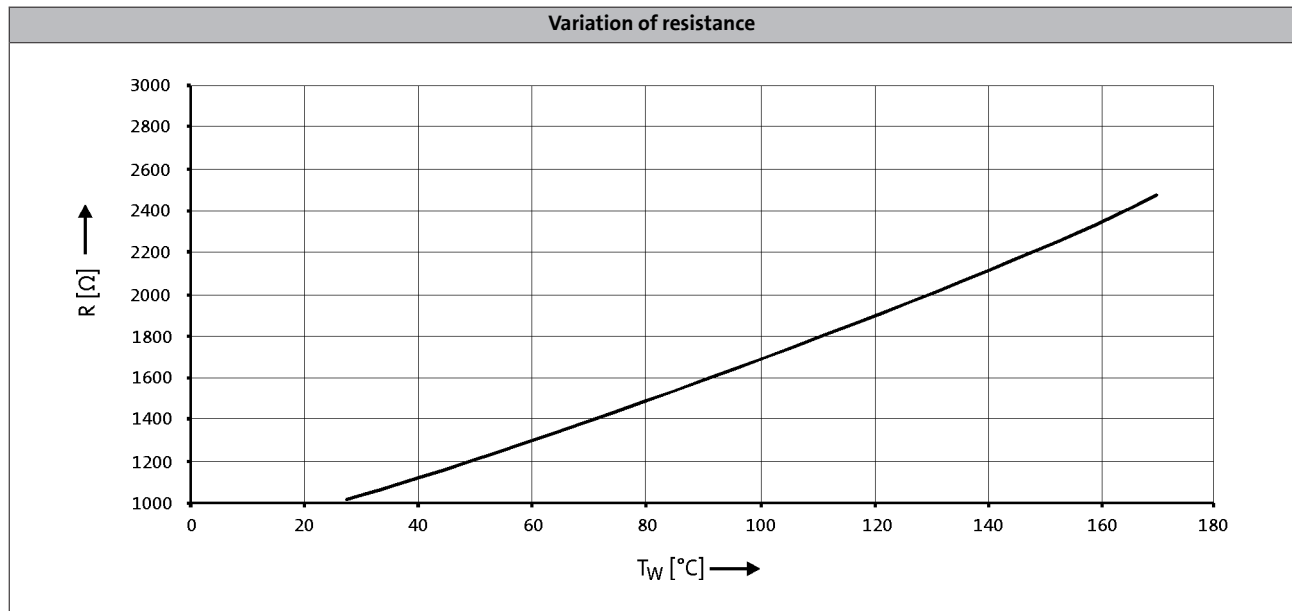

- ▶ If the detector is supplied with a measured current of 1 mA, the above relationship between the temperature and the resistance applies.

MQA asynchronous servo motors

Accessories



ICN connector

A connector is used for motor and brake connection.
The connection to the feedback system employs a separate connector.

The connectors can be rotated through 270° and are fitted with a bayonet catch for SpeedTec connectors. As the connector fixing is also compatible with conventional union nuts. Existing mating connectors can therefore still be used without difficulty.

Connection for power and brake

► MQA20

Pin assignment		
Contact	Designation	Meaning
1		Not assigned
2		
+	BD1	Holding brake +
-	BD2	Holding brake -
PE	PE	PE conductor
U	U	Phase U power
V	V	Phase V power
W	W	Phase W power

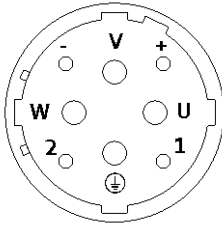
A circular diagram of the motor's terminal block. It shows seven terminals arranged in a circle. Starting from the top and moving clockwise, the terminals are labeled: V+, V-, U, 1, W, 2, and PE (indicated by a ground symbol).



ICN connector

Feedback connection

► Resolver

Pin assignment		
Contact	Designation	Meaning
1	+Ref	Transformer windings
2	-Ref	
3	+VCC ETS	Supply: Electronic nameplate
4	+COS	Cosine stator windings
5	-COS	
6	+SIN	Sine stator windings
7	-SIN	
8		Not assigned
9		
10		
11	+KTY	KTY temperature sensor
12	-KTY	

► Hiperface incremental encoder and SinCos absolute value encoder

Pin assignment		
Contact	Designation	Meaning
1	B	Track B/+SIN
2	A ⁻	Track A inverse/-COS
3	A	Track A/+COS
4	+U _B	Supply +
5	GND	Mass
6	Z ⁻	Zero track inverse/-RS485
7	Z	Zero track/+RS485
8		Not assigned
9	B ⁻	Track B inverse/-SIN
10		Not assigned
11	+KTY	KTY temperature sensor
12	-KTY	

MQA asynchronous servo motors

Technical data



ICN connector

Feedback connection

- SinCos absolute value encoder with EnDat interface

Pin assignment		
Contact	Designation	Meaning
1	U _p sensor	Supply: UP sensor
2		Not assigned
3		
4	0 V sensor	Supply: 0 V sensor
5	+KTY	KTY temperature sensor
6	-KTY	
7	+U _B	Supply +
8	Cycle	EnDat interface cycle
9	Cycle ⁻	EnDat interface inverse cycle
10	GND	Mass
11	Shield	Encoder housing screen
12	B	Track B
13	B ⁻	Track B inverse/-SIN
14	Data	EnDat interface data
15	A	Track A
16	A ⁻	Track A inverse
17	Data ⁻	EnDat interface inverse data

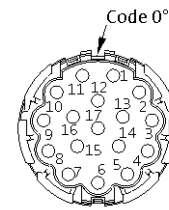

MQA asynchronous servo motors

Technical data

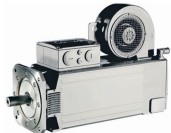

MQA asynchronous servo motors

Technical data



Internet version

Lenze SE
Hans-Lenze-Straße 1
D-31855 Aenzen
Phone: +49 (0)5154 82-0
Telefax: +49 (0)5154 82 28 00

www.Lenze.com

Lenze